

OWNER'S MANUAL

Color Television
20MS3442/17

MAGNAVOX
SMART. VERY SMART.



NEED HELP? CALL US!

MAGNAVOX REPRESENTATIVES ARE READY TO HELP YOU WITH ANY QUESTIONS ABOUT YOUR NEW PRODUCT. WE CAN GUIDE YOU THROUGH CONNECTIONS, FIRST-TIME SETUP, AND ANY OF THE FEATURES. WE WANT YOU TO START ENJOYING YOUR NEW PRODUCT RIGHT AWAY.

**CALL US BEFORE YOU CONSIDER RETURNING THE PRODUCT.
1-800-705-2000**

OR VISIT US ON THE WEB AT WWW.MAGNAVOX.COM

IMPORTANT!
RETURN YOUR WARRANTY REGISTRATION CARD WITHIN 10 DAYS.
SEE WHY INSIDE.

Return your Warranty Registration card today to ensure you receive all the benefits you're entitled to.

Once your MAGNAVOX purchase is registered, you're eligible to receive all the privileges of owning a MAGNAVOX product. So complete and return the Warranty Registration Card enclosed with your purchase at once. And take advantage of these important benefits.

Warranty Verification

Registering your product within 10 days confirms your right to maximum protection under the terms and conditions of your MAGNAVOX warranty.

Owner Confirmation

Your completed Warranty Registration Card serves as verification of ownership in the event of product theft or loss.

Model Registration

Returning your Warranty Registration Card right away guarantees you'll receive all the information and special offers which you qualify for as the owner of your model.

Congratulations on your purchase, and welcome to the "family!"



Dear MAGNAVOX product owner:

Thank you for your confidence in MAGNAVOX. You've selected one of the best-built, best-backed products available today. We'll do everything in our power to keep you happy with your purchase for many years to come.

As a member of the MAGNAVOX "family," you're entitled to protection by one of the most comprehensive warranties and outstanding service networks in the industry.

What's more, your purchase guarantees you'll receive all the information and special offers for which you qualify, plus easy access to accessories from our convenient home shopping network. Most importantly, you can count on our uncompromising commitment to your total satisfaction.

All of this is our way of saying welcome-and thanks for investing in a MAGNAVOX product.

P.S. Remember, to get the most from your MAGNAVOX product, you must return your Warranty Registration Card within 10 days. So please mail it to us right now!

Know these Safety symbols



⚡ This "bolt of lightning" indicates uninsulated material within your unit may cause an electrical shock. For the safety of everyone in your household, please do not remove product covering.

! The "exclamation point" calls attention to features for which you should read the enclosed literature closely to prevent operating and maintenance problems.

WARNING: TO PREVENT FIRE OR SHOCK HAZARD, DO NOT EXPOSE THIS EQUIPMENT TO RAIN OR MOISTURE.

CAUTION: To prevent electric shock, match wide blade of plug to wide slot, fully insert.

ATTENTION: Pour éviter les choc électriques, introduire la lame la plus large de la fiche dans la borne correspondante de la prise et pousser jusqu'au fond.

For Customer Use

Enter below the Serial No. which is located on the rear of the cabinet. Retain this information for future reference.

Model No. _____
Serial No. _____

Visit our World Wide Web Site at <http://www.magnavox.com>

IMPORTANT SAFETY INSTRUCTIONS

Read before operating equipment

1. Read these instructions.
2. Keep these instructions.
3. Heed all warnings.
4. Follow all instructions.
5. Do not use this apparatus near water.
6. Clean only with a dry cloth.
7. Do not block any of the ventilation openings. Install in accordance with the manufacturer's instructions.
8. Do not install near any heat sources such as radiators, heat registers, stoves, or other apparatus (including amplifiers) that produce heat.
9. Do not defeat the safety purpose of the polarized or grounding-type plug. A polarized plug has two blades with one wider than the other. A grounding type plug has two blades and a third grounding prong. The wide blade or third prong are provided for your safety. When the provided plug does not fit into your outlet, consult an electrician for replacement of the obsolete outlet.
10. Protect the power cord from being walked on or pinched, particularly at plugs, convenience receptacles, and the point where they exit from the apparatus.
11. Only use attachments/accessories specified by the manufacturer.
12. Use only with a cart, stand, tripod, bracket, or table specified by the manufacturer or sold with the apparatus. When a cart is used, use caution when moving the cart/apparatus combination to avoid injury from tip-over.
13. Unplug this apparatus during lightning storms or when unused for long periods of time.
14. Refer all servicing to qualified service personnel. Servicing is required when the apparatus has been damaged in any way, such as if the power-supply cord or plug is damaged, liquid has been spilled or objects have fallen into the apparatus, or if the apparatus has been exposed to rain or moisture, does not operate normally, or has been dropped.
15. This product may contain lead and mercury. Disposal of these materials may be regulated due to environmental considerations. For disposal or recycling information, please contact your local authorities or the Electronic Industries Alliance (www.eiae.org).
16. **Damage Requiring Service** - The appliance should be serviced by qualified service personnel when:
 - A. The power supply cord or the plug has been damaged;



- B. Objects have fallen or liquid has been spilled into the appliance;
 - C. The appliance has been exposed to rain;
 - D. The appliance does not appear to operate normally or exhibits a marked change in performance;
 - E. The appliance has been dropped or the enclosure damaged.
17. **Tilt/Stability** - All televisions must comply with recommended international global safety standards for tilt and stability properties of its cabinet design.
 - Do not compromise these design standards by applying excessive pull force to the front, or top, of the cabinet, which could ultimately overturn the product.
 - Also, do not endanger yourself, or children, by placing electronic equipment/toys on the top of the cabinet. Such items could unsuspectingly fall from the top of the set and cause product damage and/or personal injury.
 18. **Wall or Ceiling Mounting** - The appliance should be mounted to a wall or ceiling only as recommended by the manufacturer.
 19. **Power Lines** - An outdoor antenna should be located away from power lines.
 20. **Outdoor Antenna Grounding** - If an outside antenna is connected to the receiver, be sure the antenna system is grounded so as to provide some protection against voltage surges and built up static charges. Section 810 of the National Electrical Code, ANSI/NFPA No. 70-1984, provides information with respect to proper grounding of the mast and supporting structure, grounding of the lead-in wire to an antenna discharge unit, size of grounding connectors, location of antenna-discharge unit, connection to grounding electrodes, and requirements for the grounding electrode. See Figure below.
 21. **Object and Liquid Entry** - Care should be taken so that objects do not fall and liquids are not spilled into the enclosure through openings.
 22. **Battery usage CAUTION** - To prevent battery leakage that may result in bodily injury, property damage, or damage to the unit:
 - Install all batteries correctly, with + and - aligned as marked on the unit.
 - Do not mix batteries (old and new or carbon and alkaline, etc.).
 - Remove batteries when the unit is not used for a long time.
 23. Apparatus shall not be exposed to dripping or splashing and no objects filled with liquids, such as vases, shall be placed on the apparatus.

Note to the Cable TV system installer: This reminder is provided to call the Cable TV system installer's attention to Article 820-40 of the NEC that provides guidelines for proper grounding and, in particular, specifies that the cable ground shall be connected to the grounding system of the building, as close to the point of cable entry as practical.

Example of Antenna Grounding as per NEC - National Electrical Code

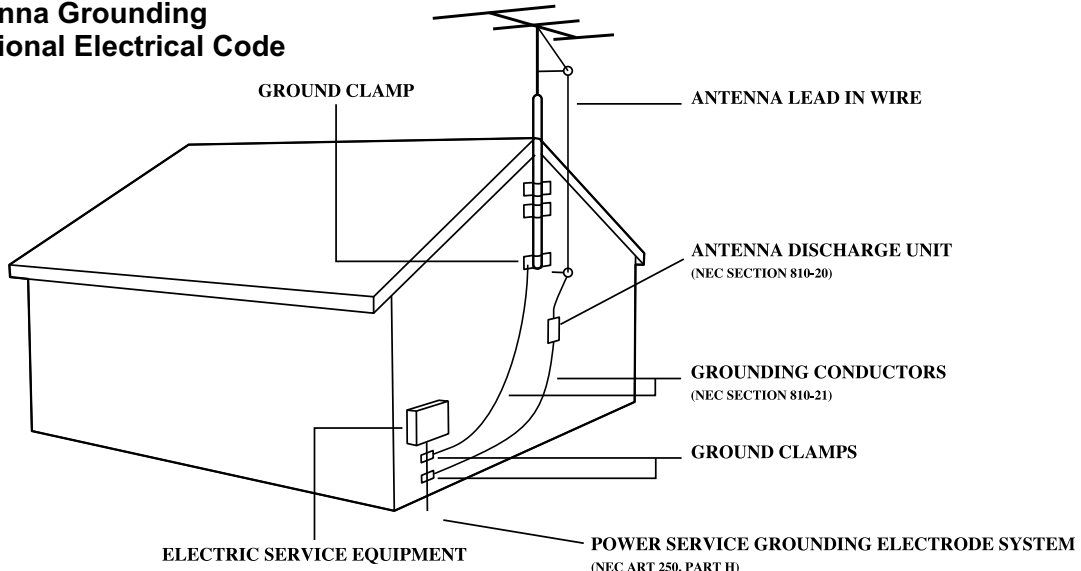

Table of Contents

Introduction

Welcome/TV Registration	2
Safety/precaution	3
Table of Contents	4
Features	4

Getting Started

Basic Cable TV connection	5
Basic Antenna Connection	6
Basic TV to VCR (Accessory) Connection	7
Basic TV and Remote Control Operations	8
Remote Control	9



Setup Menu

Language	10
TV/Cable TV	11
Auto Search (Setting TV Channels)	12
Manual Channel Tuning	13
Favorite Channel Setting	14
Adding or Erasing Channels	15



On-screen Menus

Picture Adjustments	16
SmartPicture™	17
Clock	18
On-Timer	19
Off-Timer	20
Closed Caption	21
Sleep Timer	22



Parental Lock

Understanding Parental Lock	23
Parental Lock Secret Code	24
Blocking Programming with Movie Ratings	25
Blocking Programming with TV Ratings	26
Parental Lock Blocking Options	27
Child Lock	28

Sound

SmartSound™	29
Sound Adjustments	30
Stereo and Second Audio Program	31



General Information

Helpful Hints	32
Care and Cleaning	32
Glossary	33
Index	33
Factory Service Locations	34-35
Limited Warranty	36

SmartPicture™ and SmartSound™ are registered trademarks of Philips Consumer Electronics North America. Copyright © 2003 Magnavox. All rights reserved.

Here are a few of the special features of your new Color Television.

Automatic Channel Programming: Quick and easy selection of available stations.

Child Lock: Locks the buttons on the front of the TV so it cannot be operated accidentally by young children.

Closed Captioning: Allows you to read TV program dialog or voice conversations as on-screen text.

Off-Timer: Turns off the TV at a preset time.

On-Timer: Turns on the TV at a preset time to a designated TV channel or video source.

On-screen Menus: Helpful message (in English or Spanish) for setting TV controls.

Parental Lock: Allows you to block the viewing of certain TV channels if you do not want your children viewing inappropriate material.

Remote Control: Works your TV features.

Sleep Timer: Turns off the TV within an amount of time you specify. (10-120 minutes from the current time).

SmartPicture™: Lets you set the picture's color, tint, contrast, etc. for various types of programming. Settings include Sports, Movies, Weak Signal, and Personal, which set the picture control as you want.

SmartSound™: Lets you set the TV's sound settings for the current programming. Choices include Personal, Theatre, Music, or Voice.

Standard broadcast (VHF/UHF) or Cable TV channel capability.

Stereo Capability: Includes built-in amplifier and twin-speaker system; allows reception of TV programs broadcast in stereo.

Basic Cable TV Connection



The cable TV signal into your home may be a single cable (75ohm) or may include a cable Box. In either case, the connection to the TV is easy.

If your Cable TV signal comes directly via a 75 ohm coaxial cable, use the following steps:

- 1 Connect the Cable TV signal to the 75 OHM ANTENNA INPUT jack on the rear of the TV.** Screw it down finger tight.
- 2 Plug the TV's power cord into a power outlet and turn on the TV.** Set TV/CATV to CATV as detailed in page 11. Refer to **AUTO SEARCH** to set up your available channels. Details are on page 12.

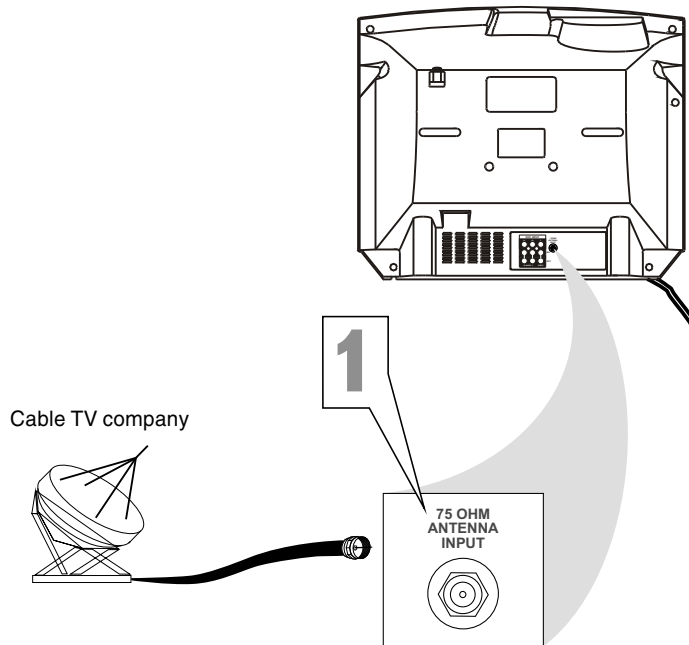

If you have a Cable Box, use the following steps.

- 1 Connect the Cable TV signal to the IN jack on the Cable Box.**
- 2 Connect the separate coaxial cable to the OUT jack on the Cable Box and to the 75 OHM ANTENNA INPUT jack on the rear of the TV.**
- 3 Plug the TV's power cord into a power outlet and turn on the TV.** Set TV/CATV to CATV as detailed in page 11.
- 4 Set the TV to channel 3 or 4** (the same as the Channel3/4 switch on your Cable Box if applicable). **Change channels at the Cable Box.**

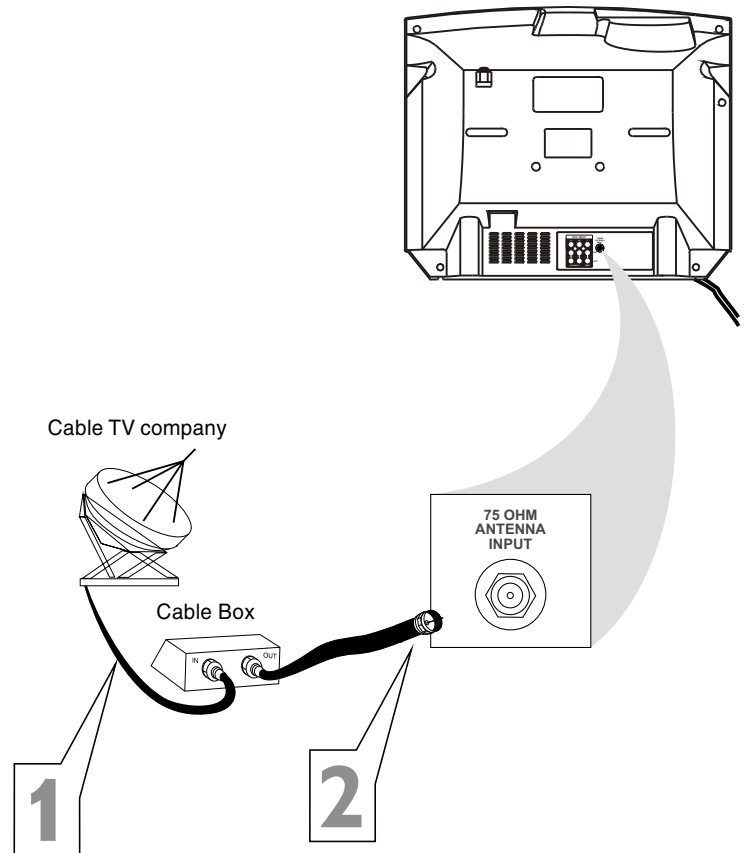

Helpful Hints

An RF coaxial cable (to connect the Cable Box to the TV) may be supplied by the Cable TV company. It is not supplied with the TV but it is available from Magnavox or electronics retailers. You can connect a Satellite Receiver the same way you would connect a Cable Box.

Your Cable Box may have separate Audio and Video Out jacks instead. If so, use audio and video cables to connect the AUDIO/VIDEO OUT jacks of the Cable Box to the AUDIO/VIDEO IN2 jacks on the rear of the TV. Press the TV/AV on the remote control to set the TV to the AV2 channel. Change channel at the Cable Box.



Basic Antenna Connection

A combination antenna receives normal broadcasting channels (VHF2-13 and UHF 14-69). Your connection is easy since you will connect the antenna to the 75OHM ANTENNA INPUT jack on the rear of the TV.

- 1** If your antenna has a round cable (75 ohm) on the end, then you are ready to connect it to the TV. Go to step 2.
- If your antenna has flat twin-lead wire (300 ohm), you first need to attach the antenna wire to the screws on a 300 to 75 ohm adapter (not supplied with TV).

- 2** Push the round end of the adapter or antenna cable onto the 75 OHM ANTENNA INPUT jack on the rear of the TV. If the round end of the antenna cable is threaded, screw it down finger tight.

- 3** Plug the TV's power cord into a power outlet and turn on the TV. Set TV/CATV to CATV as detailed on page 11. Refer to **AUTO SEARCH** to set up your available channels. Details are on page 12.

Note: this TV has no hand grip, which is a recess at either side of the cabinet for ease of transportation of bigger sets.

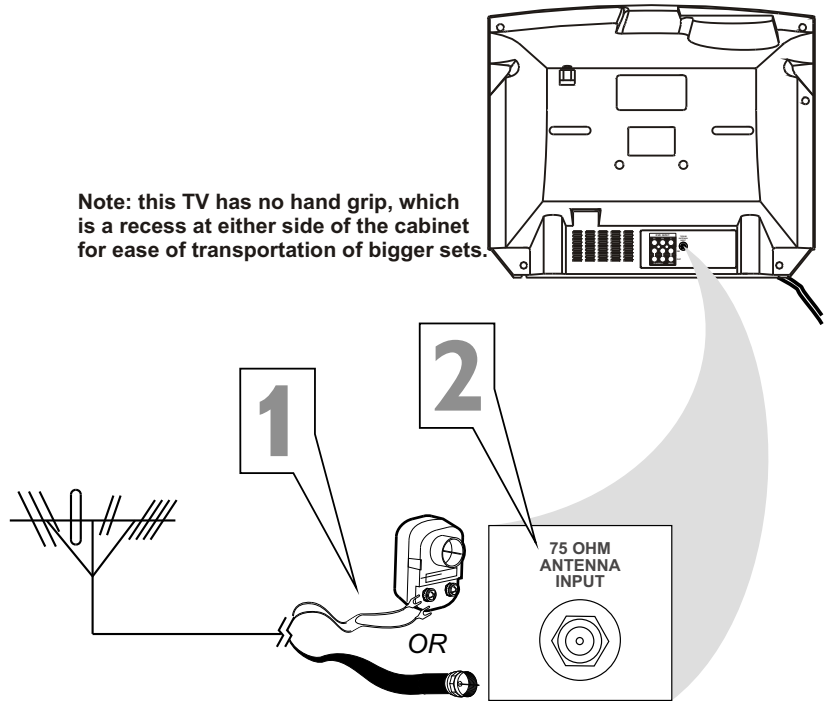

If you have separate UHF and VHF antennas, you need an optional combiner to connect to the TV.

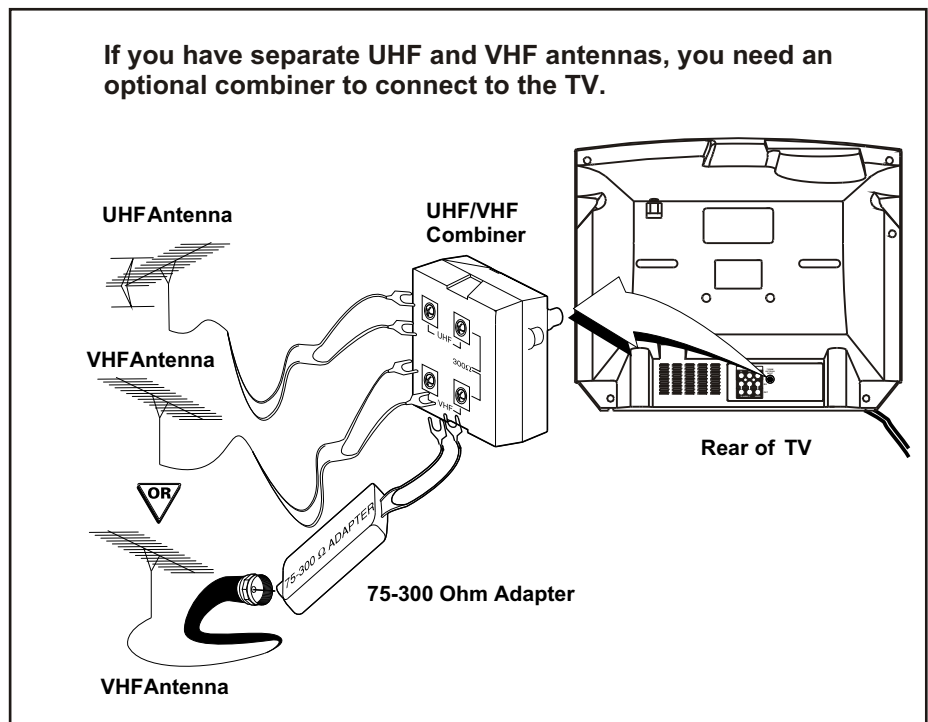

Basic TV to VCR (Accessory) Connection



The basic Antenna/Cable TV to Accessory (VCR, DVD Player, etc.) to TV connection is shown at right. For other hookups (such as those with Cable Boxes), refer to the owner's manual of the Cable Box or other Accessories.

- 1** Connect a yellow video cable to the VIDEO IN2 jack on the rear of the TV and to the VIDEO OUT jack on your VCR (or other Accessories.)
- 2** Connect red and white audio cables to the AUDIO IN2 jacks (left and right) on the rear of the TV and to the AUDIO OUT jacks on your VCR (or other device.) Match the cable colors to the jack colors.
- 3** Turn on the TV and the VCR.
- 4** Press the TV/AV button on the TV's remote control until AV2 appears in the upper right corner of the TV screen. When you play material on the VCR, DVD player, etc. that is connected to the AUDIO and VIDEO IN2 jacks on the rear of the TV, it will appear on the TV on the AV2 channel.

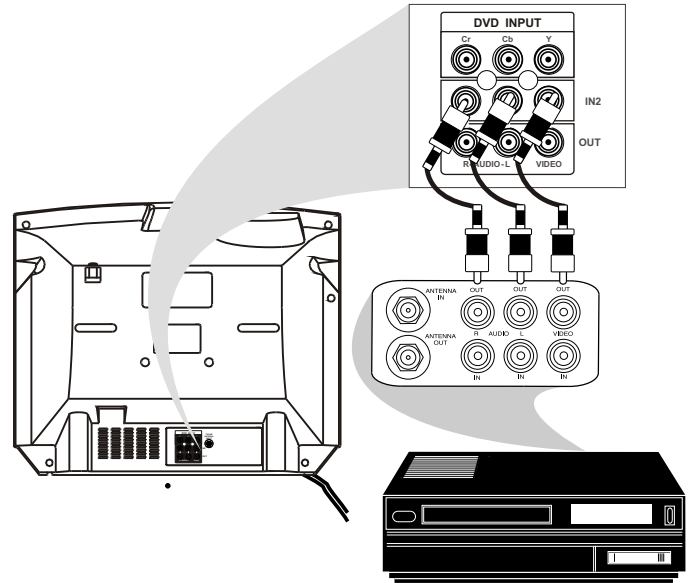

There are AUDIO and VIDEO IN1 jacks at the lower-right corner of the rear of the TV set. To view material playing on equipment connected here, press the TV/AV so AV1 is shown on the TV.

There is also an S-VIDEO IN1 jack in this area. Use S-Video connection if your DVD player, camcorder, etc. has an S-Video Out jack. S-Video provides a clearer picture than the standard CVBS video (the yellow jack). Choose the AV1 channel to view material playing on equipment connected to the S-VIDEO IN1 jack.

Use either S-VIDEO IN1 jack or VIDEO IN1 jacks. Do not use both at the same time for the same piece of equipment.

This would interfere with the picture display. If both are used, S-VIDEO IN1 has priority over the yellow VIDEO IN1 jack.

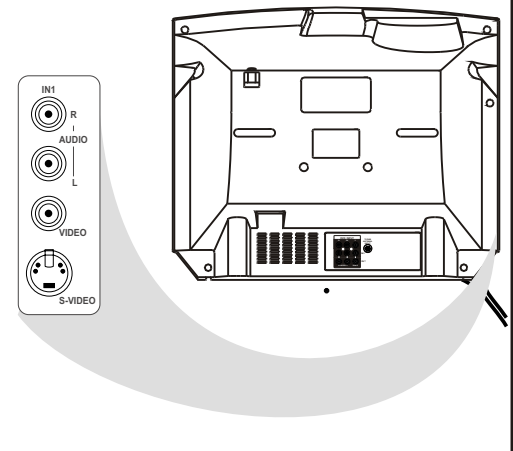

Helpful Hints

Audio and video cables are not supplied with the TV but are available from Magnavox or electronics retailers. Audio cables are usually red and white. Video cables (CVBS) are usually yellow.

You can connect the antenna or Cable TV signal to either the ANTENNA IN jack on your VCR or to the 75 OHM ANTENNA INPUT jack on the TV. If you connect it to the VCR, choose TV channels at the VCR. Connect it to the VCR if you want to record TV programming through VCR.

Your VCR may not have Audio and Video Out jacks, but only An RF or ANTENNA OUT jack. Use a coaxial cable to connect the VCR's ANTENNA OUT jack to the TV's 75 OHM ANTENNA INPUT jack.

There are Component Video In jacks on the rear of the TV. These are labeled DVD INPUT Y, Cb and Cr and are red, blue and green. Use these to connect a DVD player that has Component Video Out jacks. This will provide the best picture quality. Use Component Video cables, which are not supplied with the TV.

If you connect the DVD player to the DVD jacks, set the TV to YUV channel to watch DVDs. Press TV/AV button on the remote so YUV appears on the TV screen. Use either DVD or VIDEO In2 jacks, but do not use both for the same piece of equipment. You only need one video connection per each accessory (DVD player, etc.).

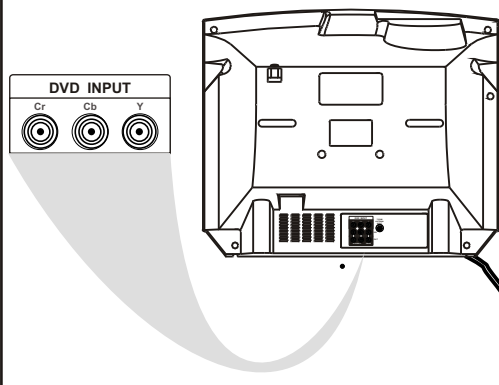



Basic TV and Remote Control Operations

Television

- 1 Press **POWER** to turn on the TV.
- 2 Press **VOL. ▲** to increase the sound level. Press **VOL. ▼** to lower the sound level.
- 3 Press **CH. ▼** or **CH. ▲** to select TV channels.
- 4 Press **MENU** to see the TV's on-screen menu. In the menu, use **VOL. ▼/▲** and **CH. ▼/▲** buttons to make adjustments or selections.
You can press **MENU** on either the remote control or the front of the TV to access or remove the menu.

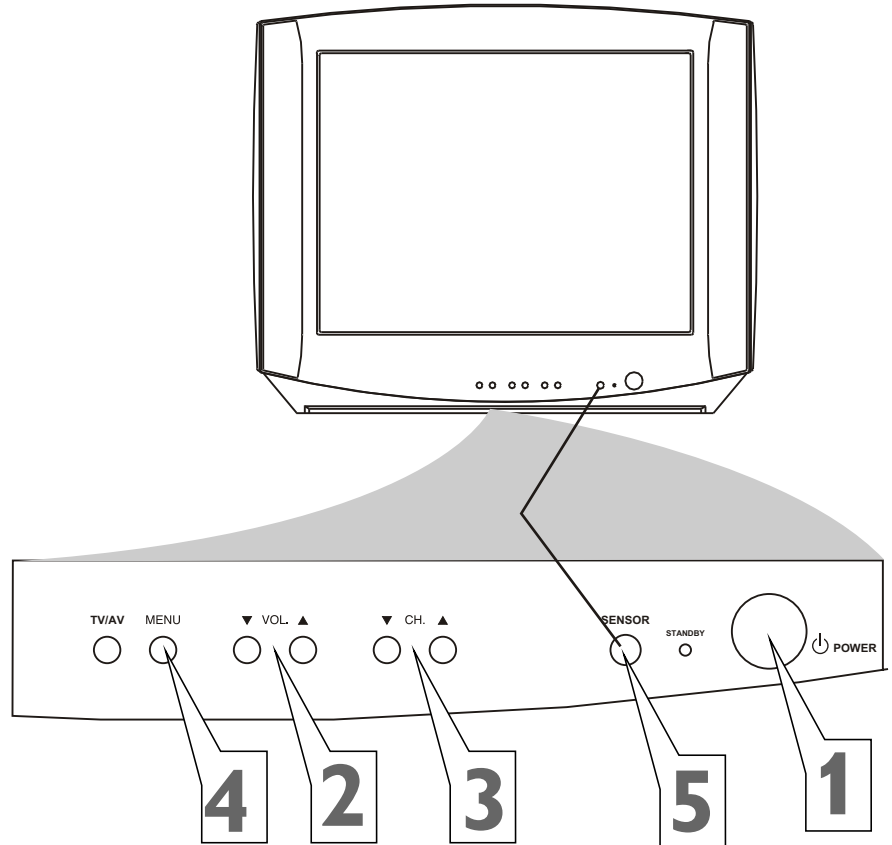

Remote control

- 5 Point the remote control toward the remote sensor on the front of the TV when operating the TV with the remote control.

Battery Installation

To load batteries into the remote control:

- 1 Remove the battery compartment lid on the rear of the remote. Press in the tab, then lift off the lid.
- 2 Place two AA batteries in the remote. Be sure the (+) and (-) ends of the batteries line up correctly (as marked inside the battery compartment).
- 3 Reattach the battery compartment lid.

Battery Installation

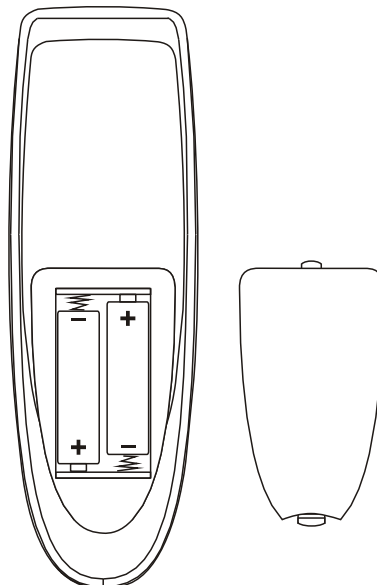

Helpful Hints

The channel number will appear briefly when you change channels. Or, press **DISPLAY** on the remote to see the channel number.

Press **TV/AV** on the front of the TV to choose **AV1/S-Video**, **AV2**, or **YUV**.

Remote Control



TV/AV Button

Press to select TV channels or the Audio /Video IN channels (AV1/S-VIDEO, AV2, or YUV).

A/CH Button

In TV mode, press to return to the previous channel.
Note: In AV mode, press A/CH to only enter TV mode.

DISPLAY

Press to see the current channel number on the TV screen. Press again to display the current time on the screen.
Press to remove a menu from the screen.

SLEEP Button

Press to select a time period (120 minutes to 10 minutes in 10- minute decrements) after which the TV will turn itself off. Details are on page 22.

MTS Button

Press to select a sound mode if available with the TV programming: MONO, STEREO, SAP and MONO+SAP. Details are on page 31.

MENU Button

Press to see the TV's on-screen menu. Press to go back to the previous menu or to remove a menu from the screen.

FAVORITE Button

Press to browse the channels preset in Favorite List. Details are on page 14.

SMART PICTURE Button

Press to select one of the four picture settings (Personal, Movies, Sports, Weak Signal). Details are on page 17.

VOL(ume) +/- Button

Press to adjust the TV sound level.

STANDBY (POWER) Button

Press to turn the TV on or off (standby). You also can turn on the TV by pressing the CH(annel) ▼/▲ buttons on the front of the TV.

NUMBER Buttons

Press to select TV channels directly. For single-digit channels, press two "0" first, then the number of the channel. For double-digit channels, press first digit then follow by another number of the channel. For example, to choose channel 45, press number 4 then follow by number 5.
For channels 100 and above, press three number buttons of the channel directly. (You can select channels above 69 only if you have Cable TV. Make sure TV/CATV is set to CATV. Details are on page 11.)

MUTE Button

Press to cancel or restore the TV sound. Pressing the volume buttons (VOL ▲ or VOL +) also will cancel mute and restore the sound.

OK Button

Within on-screen menu, press to enter some special function, such as Favorite List, etc..

SMART SOUND Button

Press to select one of the four sound settings (Voice, Music, Theatre, or Personal). Details are on page 29.

CH(annel) +/- Button

Press to select memorized TV channels.

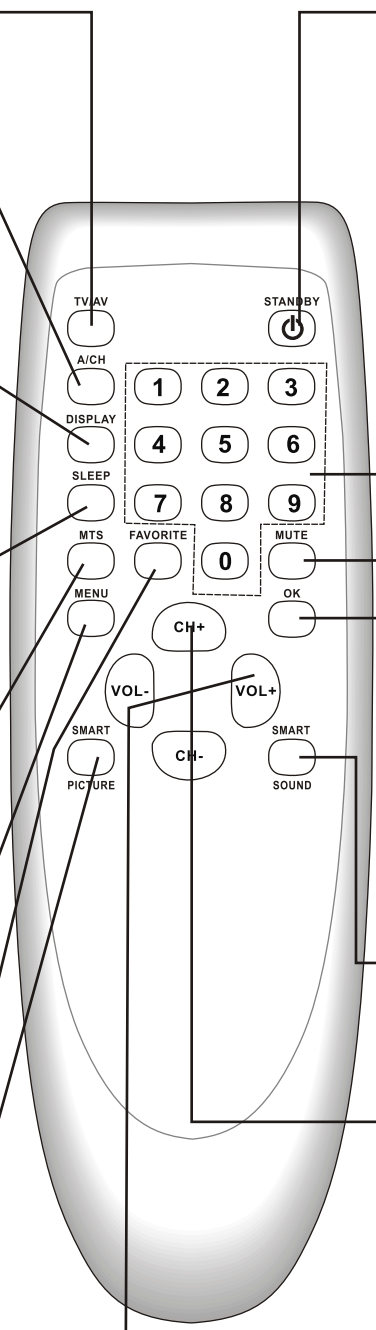



Language

You can set the TV's on-screen menu to English or Spanish.

- 1** Press **MENU** to see the menu.
- 2** Press **VOL+** or **VOL-** to highlight **Feature** (Feature).
- 3** Press **CH-** to highlight **Language**.
- 4** Press **VOL+** or **VOL-** to select **English** or **Espanol** (Spanish).
- 5** Press **MENU** repeatedly to remove the menu from the screen or the menu will automatically disappear within a few seconds if no buttons are pressed on the remote control.

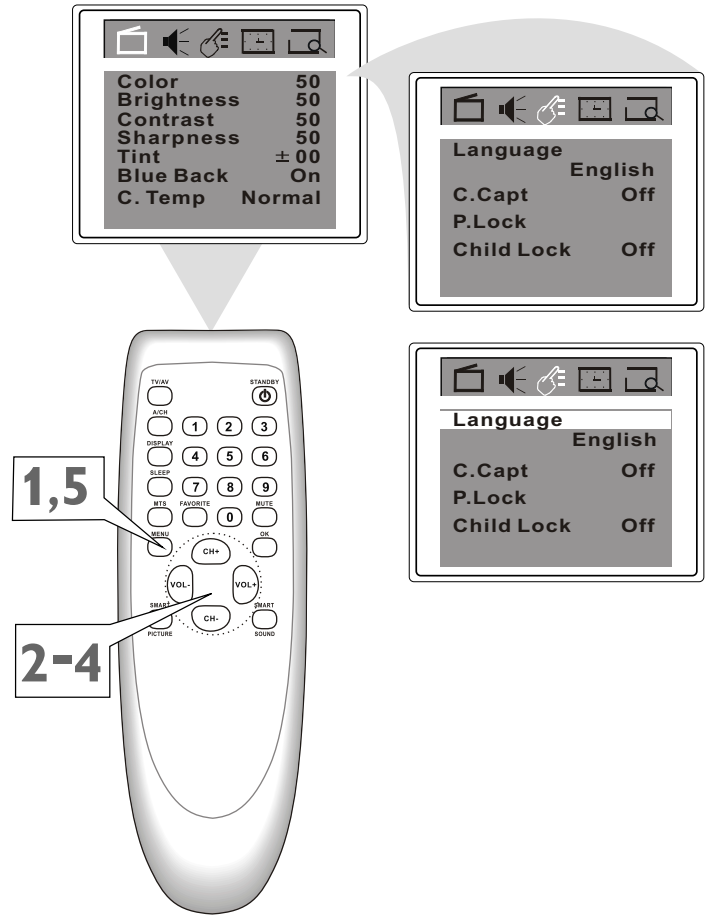

Helpful Hints

The language control only affects the language of the TV menus. It does not change the other on-screen text features, such as Closed Captions.

TV/Cable TV(CATV)



It is important for the TV to know what type of signal-Cable TV (CATV) or a normal antenna-you are using. To tell the TV whether you are using a cable TV signal, set TV/CATV to TV or CATV as follows.

- 1 Press MENU** to see the menu.
- 2 Press VOL+ or VOL-** to highlight (Preset).
- 3 Press CH-** to enter **Preset** submenu. **TV/CATV** is highlighted.
- 4 Press VOL+ or VOL-** to select **TV** or **CATV**.
Choose CATV if you have Cable TV service. (See page five for connection details.) If you do not have Cable TV service and you connected an antenna to the TV, choose TV. (See page six for connection details.)
- 5 Press MENU repeatedly** to remove the menu from the screen or the menu will automatically disappear within a few seconds if no buttons are pressed on the remote control.

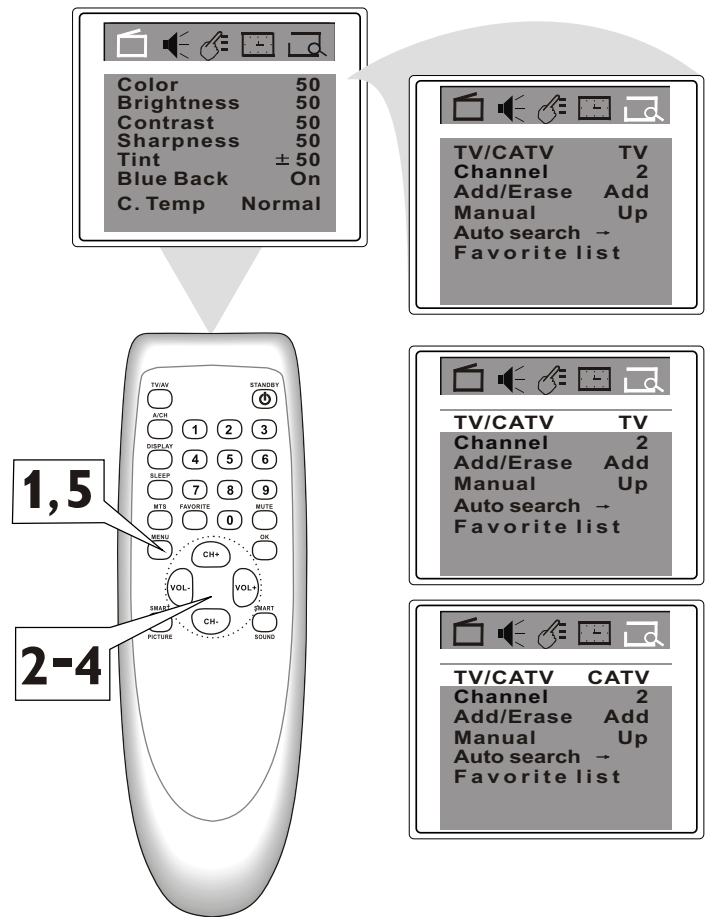

Helpful Hints

When CATV is selected, channels 1-125 are available.

When TV is selected, only channels 2-69 are available.

You cannot select Preset if the TV is set to AV1/S-video, AV2, or YUV. Press TV/AV repeatedly to get to the TV channels.



Auto Search (Setting TV Channels)

You can set your TV to receive local TV channels (From an antenna) or Cable TV channels (when you have Cable TV service). Then, use Auto search to set up channels that are available for you. This makes it easy for you to select only the available TV stations when you press CH+ or CH-. Before you start auto search, connect the Antenna or Cable TV signal as detailed on pages five and six; set TV/CATV as described on page 11.

- 1** Press **MENU** to see the menu.
- 2** Press **VOL+** or **VOL-** to highlight  (**Preset**).
- 3** Press **CH-** to enter **Preset** submenu.
- 4** Press **CH+** or **CH-** repeatedly to highlight **Auto search**.
- 5** Press **VOL+** to start programming TV channels. Press the **VOL-** if you need to stop channel programming during the process.
When channel setup is completed, the TV will go to its lowest channel.

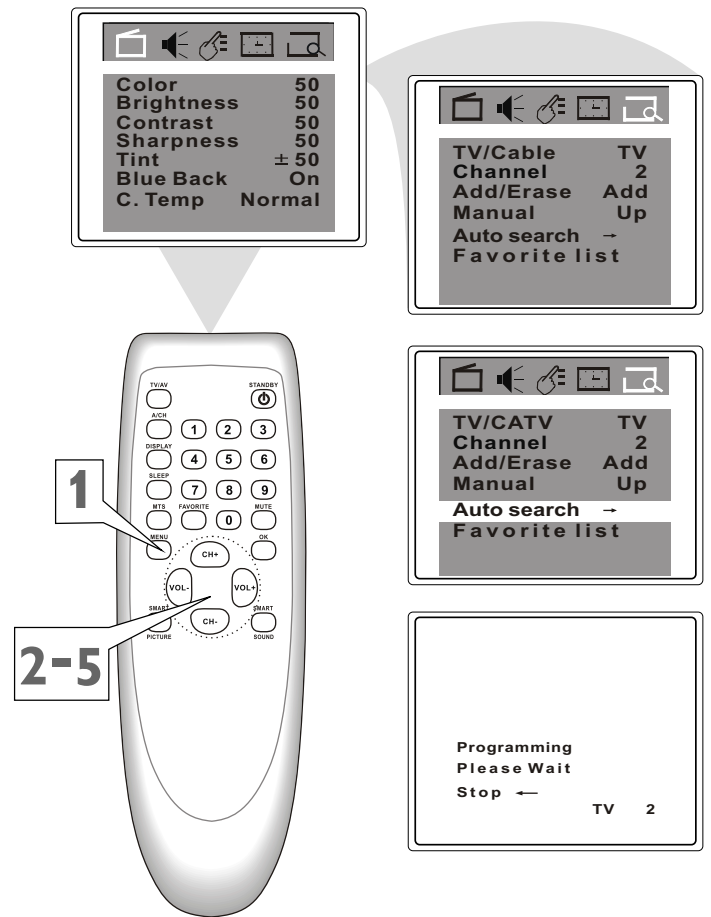

Helpful Hints

Press CH+ or CH- to see which channels are in the TV's memory. You can still select non-memorized channels using the Number buttons on the remote control.

To delete unwanted channels from the TV's memory or to add more channels, see ADD/ERASE on page 15.

You cannot select **Preset menu** if the TV is set to AV1/S- video, AV2, or YUV. Press TV/AV repeatedly to get to the TV channels.

Manual Channel Tuning



Manual Channel Tuning lets you quickly select the next available channel. For example, if you are looking for a channel between 60 and 70, start the search at channel 60 and go up.

- 1** Press **MENU** to see the menu.
- 2** Press **VOL+** or **VOL-** to highlight **TV** (Preset).
- 3** Press **CH-** to enter **Preset** submenu.
- 4** Press **CH+** or **CH-** repeatedly to highlight **TV/CATV**.
- 5** Press **VOL+** or **VOL-** to select TV or CATV (whichever you have). Details are on page 11.
- 6** Press **CH+** or **CH-** repeatedly to highlight **Channel**.
- 7** Press **VOL+** or **VOL-** to enter the channel number at which you want to begin the search.
- 8** Press **CH+** or **CH-** repeatedly to highlight **Manual**.
- 9** Press **VOL+** to start searching upward (for example, starting at channel 60 and going up to 61, 62, 63, etc.). Press **VOL-** when you find the channel you want. This stops the search. Otherwise the search will stop at the first available channel.

Or, press **VOL-** to start searching downward (for example, starting at channel 60 and going down to 59, 58, 57, etc.). Press **VOL+** when you find the channel you want. This stops the search. Otherwise the search will stop at the first available channel.

- 10** Press **MENU** repeatedly to remove the menu from the screen or the menu will automatically disappear within a few seconds if no buttons are pressed on the remote control.

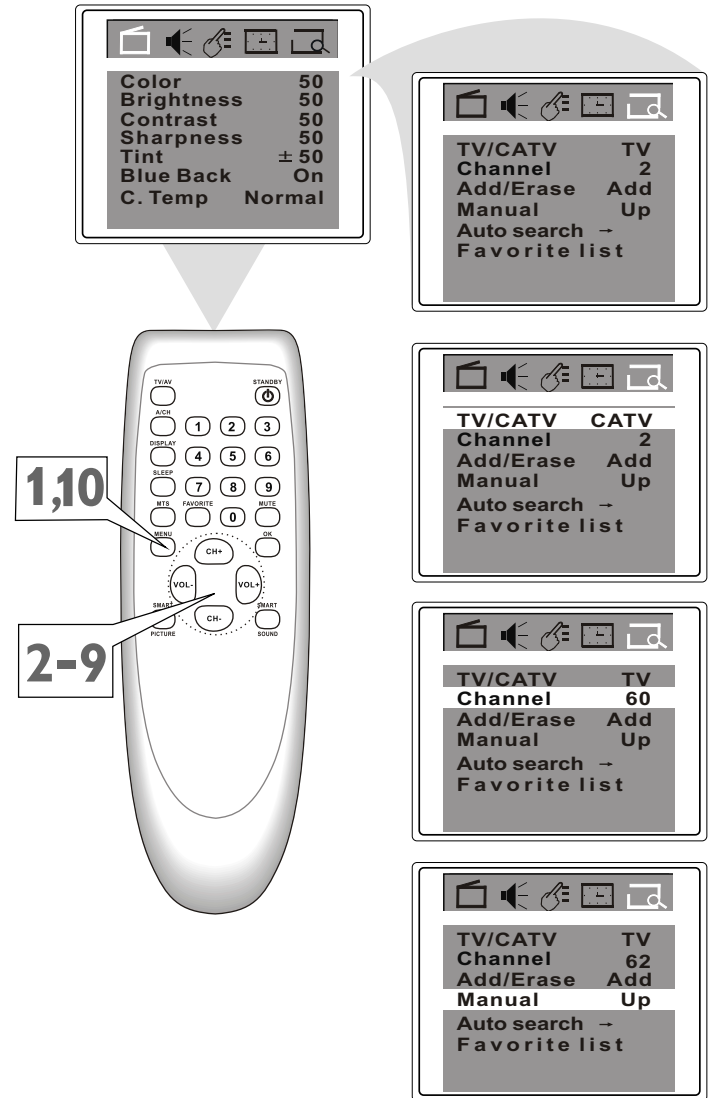

or

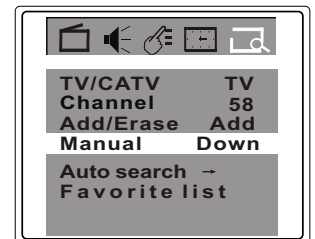

Helpful Hints

You cannot select **Preset** if the TV is set to AV1/S-video, AV2, or YUV. Press TV/AV repeatedly to get to the TV channels.



Favorite Channel Setting

You can store five channels you prefer into the Favorite list and recall these channels easily by press the FAVORITE button on the remote control.

- 1** Press **MENU** to see the menu.
- 2** Press **VOL+** or **VOL-** to highlight (Preset).
- 3** Press **CH-** to enter **Preset** submenu.
- 4** Press **CH+** or **CH-** repeatedly to highlight **Favorite list**.
- 5** Press **OK** to display features of **Favorite list**.
- 6** **TV/CATV** is highlighted. Press **VOL+** or **VOL-** to select TV or CATV (whichever you have).
- 7** Press **CH+** or **CH-** to select Ch3 (or Ch1, Ch2, Ch4, Ch5), then Press **VOL+** or **VOL-** to enter a channel number you want to store at this position, such as CATV 8.
- 8** Press **MENU** repeatedly to remove the menu from the screen or the menu will automatically disappear within a few seconds if no buttons are pressed on the remote control.

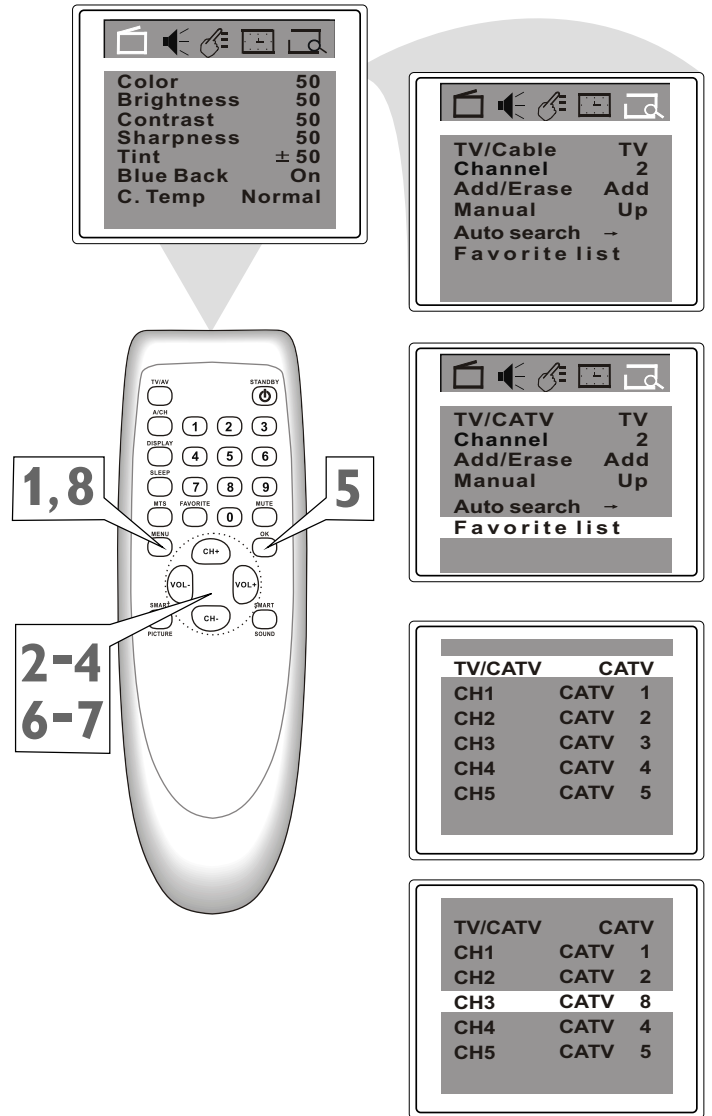

Helpful Hints

You cannot select **Preset** if the TV is set to AV1/S-video, AV2, or YUV. Press TV/AV repeatedly to get to the TV channels.

Adding or Erasing Channels



You can add or erase channels from the list in the TV's memory.

- 1** Using the **Number buttons**, select the channel you wish to add or erase.
- 2** Press **MENU** to see the menu.
- 3** Press **VOL+** or **VOL-** to highlight  (**Preset**).
- 4** Press **CH-** to enter **Preset** submenu.
- 5** Press **CH+** or **CH-** repeatedly to highlight **Add/Erase**.
- 6** Press **VOL+** or **VOL-** to choose **Add or Erase**.
If you select **Add**, the channel will be available when you press **CH+** and **CH-** to move through channels. Choosing **Erase** will remove the channel from the TV's memory. The channel will not be available when you flip through channels with the **CH+** and **CH-** buttons.
- 7** Press **MENU** repeatedly to remove the menu from the screen or the menu will automatically disappear within a few seconds if no buttons are pressed on the remote control.

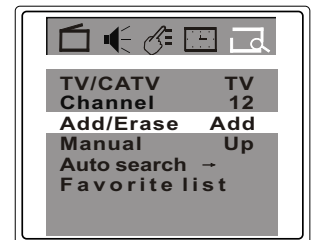
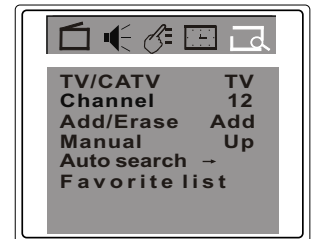
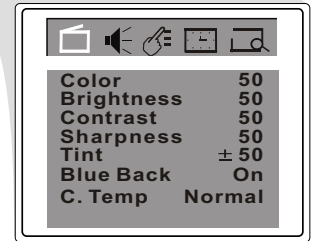
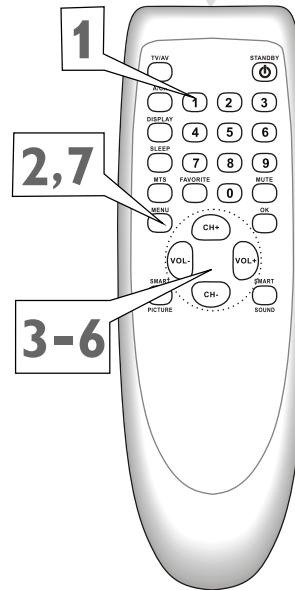

or

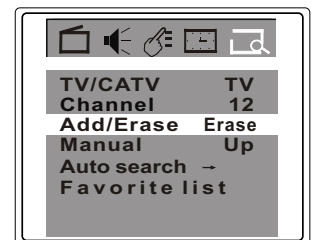

Helpful Hints

You cannot select **Preset** if the TV is set to AV1/S-video, AV2, or YUV. Press TV/AV repeatedly to get to the TV channels.



Picture Adjustment

To adjust your TV picture, select a channel and follow the steps below:

- 1 Press MENU** to see the menu.
- 2 Press CH-** to enter (Picture) submenu.
- 3 Press CH+ or CH-** repeatedly to highlight your choice: Color, Brightness, Contrast, Sharpness, Tint, Blue Back (background), or C.Temp (color temperature.)
- 4 Press VOL+ or VOL-** to increase or decrease the element you choose. However, you can turn Blue Back to only On or Off (see below). You can choose Warm, Cool or Normal mode for color temperature.
- 5 Press MENU repeatedly** to remove the menu from the screen or the menu will automatically disappear within a few seconds if no buttons are pressed on the remote control.

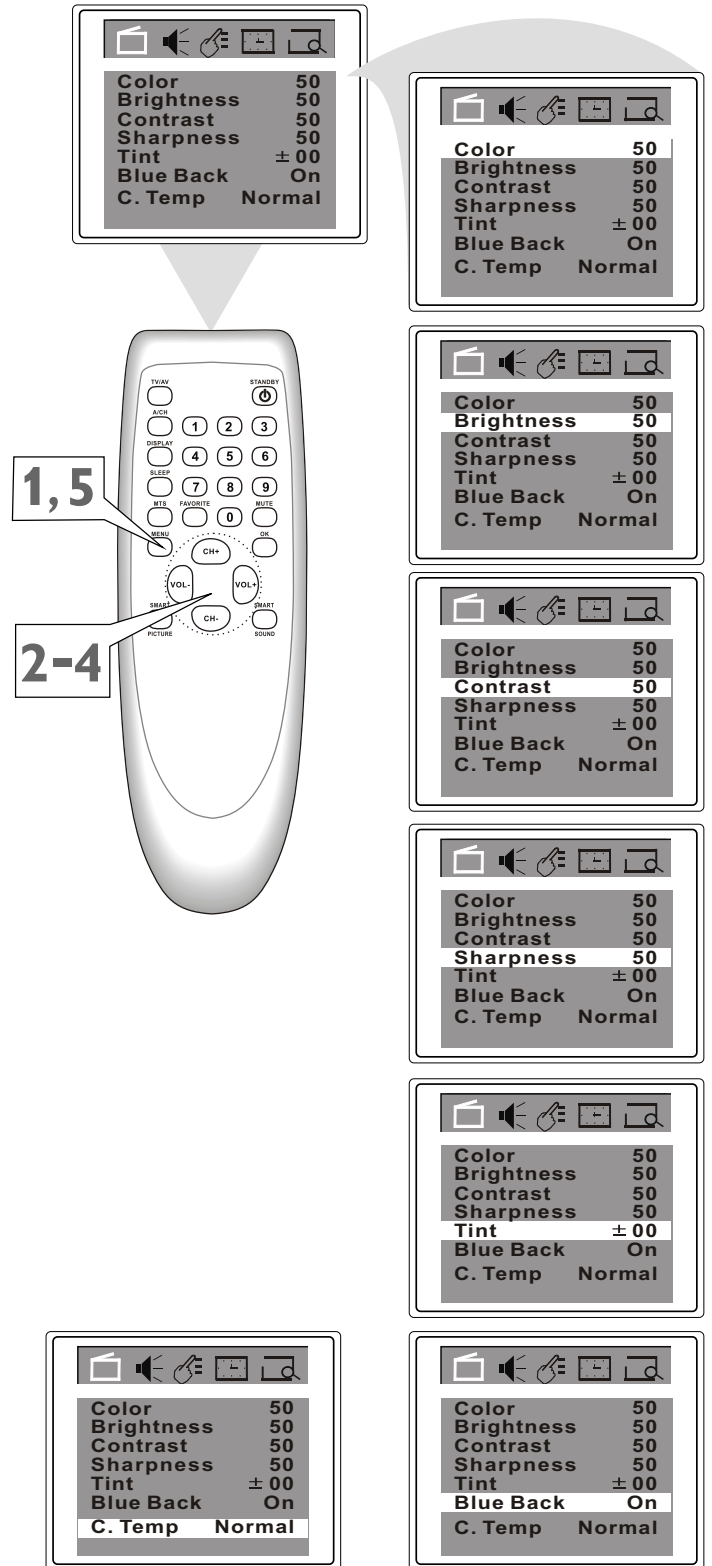

Helpful Hints

Color: Adjust to add or reduce color.

Brightness: Adjust to brighten the darkest parts of the picture.

Contrast: Adjust the distinction between the black and white parts of the picture.

Sharpness: Improve picture detail.

Tint: Obtain natural skin tones.

Blue Back: Turn this option ON or OFF. If you choose ON, a solid blue background screen will appear if the TV is on a weak channel (for example, if the reception is very poor or if the station has gone off the air for the night). After being on such channel for 15 minutes, the TV will turn itself off automatically.

C. Temp: Set this option to Normal, Warm or Cool mode.

Smart Picture



SmartPicture presets your TV's video settings for different types of programs and viewing conditions. Each SmartPicture setting is preset at the factory to automatically adjust the TV's Brightness, Color, Contrast, Sharpness.

1 Press **SMART PICTURE** on the remote control. The current SmartPicture setting will appear on the screen.

2 Press **SMART PICTURE** repeatedly to select Personal, Movies, Sports, or Weak Signal.

The Personal setting is what you specify with the picture adjustments as described on page 16. Personal is the only Smart Picture setting you can change. All others are set at the factory during production.

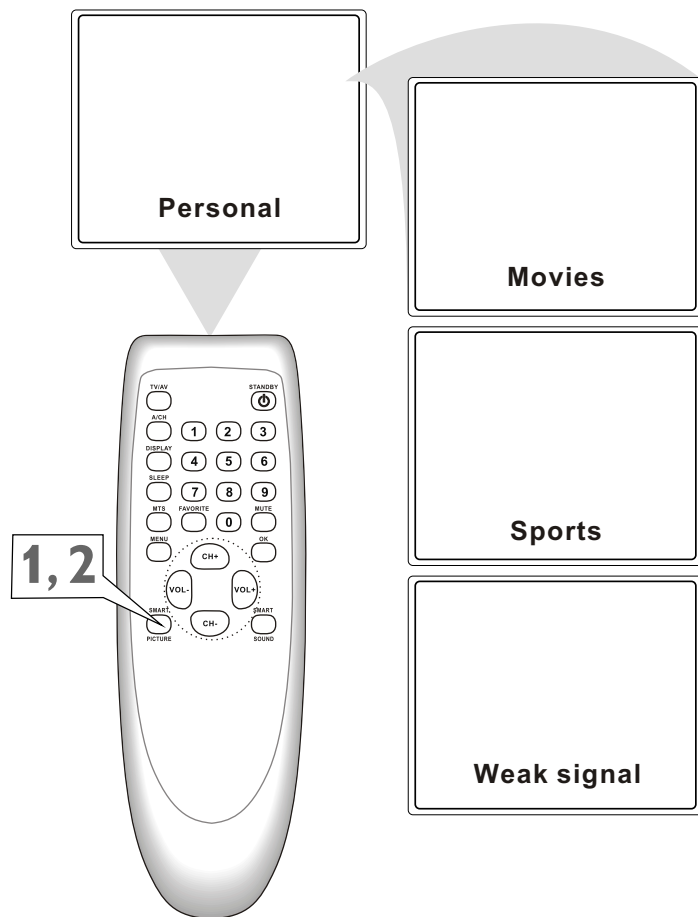



Clock

Follow these steps to set your TV's clock.

- 1** Press **MENU** to see the menu.
- 2** Press **VOL+** or **VOL-** to highlight  (Timer).
- 3** Press **CH-** to enter **Timer** submenu.
- 4** Press **CH+** or **CH-** repeatedly to highlight **Clock**.
- 5** Press **VOL+** or **VOL-** to enter the current time. Press and hold the **VOL+** or **VOL-** to change the time quickly in 10 minute increments.
- 6** Press **MENU** repeatedly to remove the menu from the screen or the menu will automatically disappear within a few seconds if no buttons are pressed on the remote control.

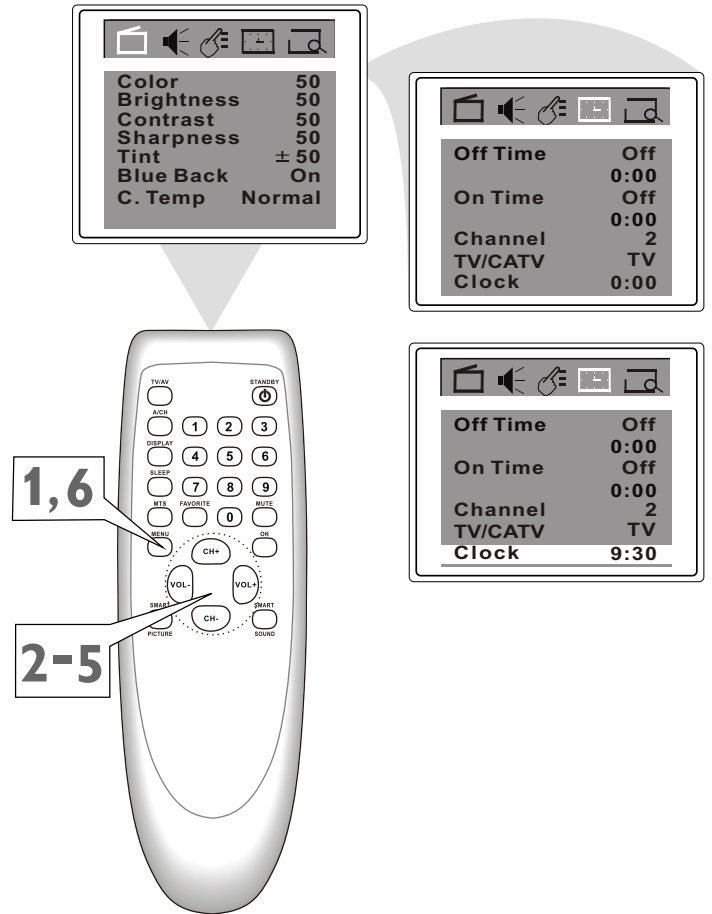

Helpful Hints

If the power fails, you must reset the clock.

On-Timer



To turn on the TV to a specific channel at a specific time, use the On-Timer. Before you begin, set the clock correctly. Details are on page 18.

- 1 Press MENU** to see the menu.
- 2 Press VOL+ or VOL-** to highlight (Timer).
- 3 Press CH-** to enter **Timer** submenu.
- 4 Press CH+ or CH-** repeatedly to highlight **Channel**.
- 5 Press VOL+ or VOL-** to enter the channel number. This will be the channel to which the TV turns on at the specified time.
- 6 Press CH+ or CH-** repeatedly to highlight **TV/CATV**.
- 7 Press VOL+ or VOL-** to select TV or CATV, depending on whether you have Cable TV service or not. Details are on page 11.
- 8 Press CH+ or CH-** repeatedly to highlight **On time**.
- 9 Press VOL+ or VOL-** to select **Once (or Daily, Off)**.
If you select Once, the timer will turn on the TV one time within the next 24 hours only.
If you select Daily, the timer will turn on the TV at the same time and to the same channel every day.
Choose Off to cancel the On-timer.
- 10 Press CH+ or CH-** repeatedly to highlight **0: 00** under the line of On Time.
- 11 Press VOL+ or VOL-** to enter the On time. Hold down VOL+ or VOL- to change the time quickly in 10-minute increments. This will be the time at which the TV will turn itself on.
- 12 Press MENU repeatedly** to remove the menu from the screen or the menu will automatically disappear within a few seconds if no buttons are pressed on the remote control.

1,12

2-11

Color	50
Brightness	50
Contrast	50
Sharpness	50
Tint	± 50
Blue Back	On
C. Temp	Normal

Off Time	Off
On Time	Off
Channel	0:00
TV/CATV	2
Clock	9:30

Off Time	Off
On Time	Off
Channel	0:00
TV/CATV	12
Clock	9:30

Off Time	Off
On Time	Off
Channel	12
TV/CATV	TV
Clock	9:30

Off Time	Off
On Time	Once
Channel	0:00
TV/CATV	12
Clock	9:30

Off Time	Off
On Time	Once
Channel	11:30
TV/CATV	12
Clock	9:30



Off-Timer

To turn off the TV at a specific time every day, use the Off-Timer. Before you begin, you must set the clock correctly. Details are on page 18.

- 1** Press **MENU** to see the menu.
- 2** Press **VOL+** or **VOL-** to highlight  (Timer).
- 3** Press **CH-** to enter **Timer** submenu.
- 4** Press **CH+** or **CH-** repeatedly to highlight **Off time**.
- 5** Press **VOL+** or **VOL-** to **Once (or Daily, Off)**.
If you select Once, the timer will turn off the TV once.
If you select Daily, the timer will turn off the TV at the same time every day.
Choose Off to cancel the Off-timer.
- 6** Press **CH+** or **CH-** repeatedly to highlight **0:00** under the line of Off Time.
- 7** Press **VOL+** or **VOL-** to enter the Off time. Hold down **VOL+** or **VOL-** to change the time quickly in 10-minute increments. This will be the time at which the TV will turn itself off.
- 8** Press **MENU** repeatedly to remove the menu from the screen or the menu will automatically disappear within a few seconds if no buttons are pressed on the remote control.

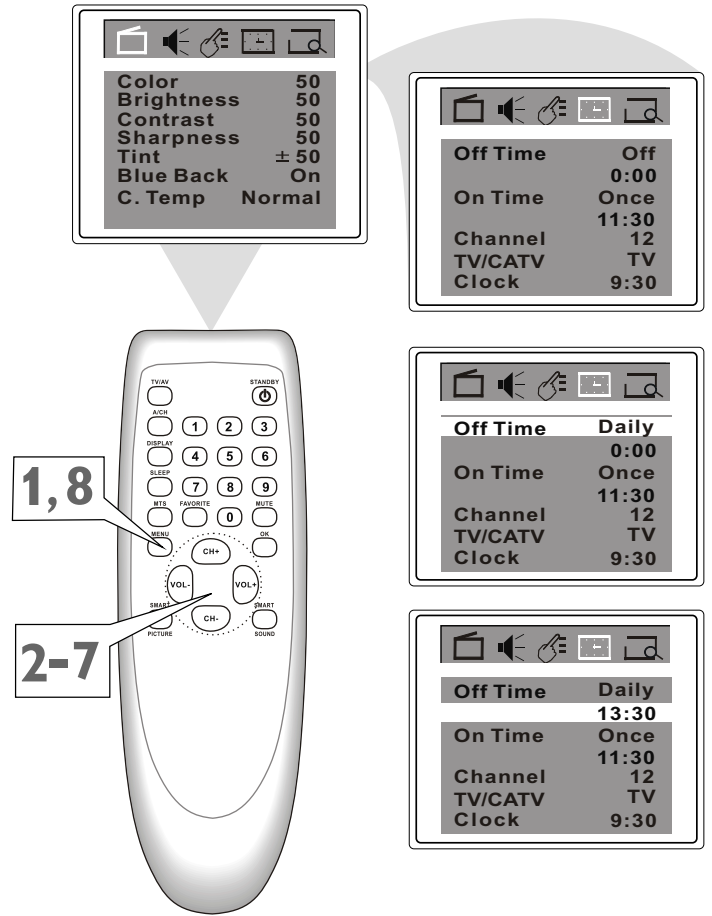

Closed Captions



Closed captioning (CC) lets you read the voice content of TV programs on the TV screen. Designed to help the hearing impaired, on-screen text boxes will show dialog, conversation, and activity during TV programming.

- 1 Press **MENU** to see the menu.
- 2 Press **VOL+ or VOL-** to highlight  (Feature).
- 3 Press **CH-** to enter Feature submenus.
- 4 Press **CH+ or CH-** to highlight **C.Capt**.
- 5 Press **VOL+ or VOL-** to select the closed caption you want (**Off, C1, C2, or C.Mute**). C.Mute sets the TV to show closed caption when you press MUTE. The TV volume will be disabled until you press MUTE or VOL+ again to restore the sound.
- 6 Press **MENU** repeatedly to remove the menu from the screen or the menu will automatically disappear within a few seconds if no buttons are pressed on the remote control.

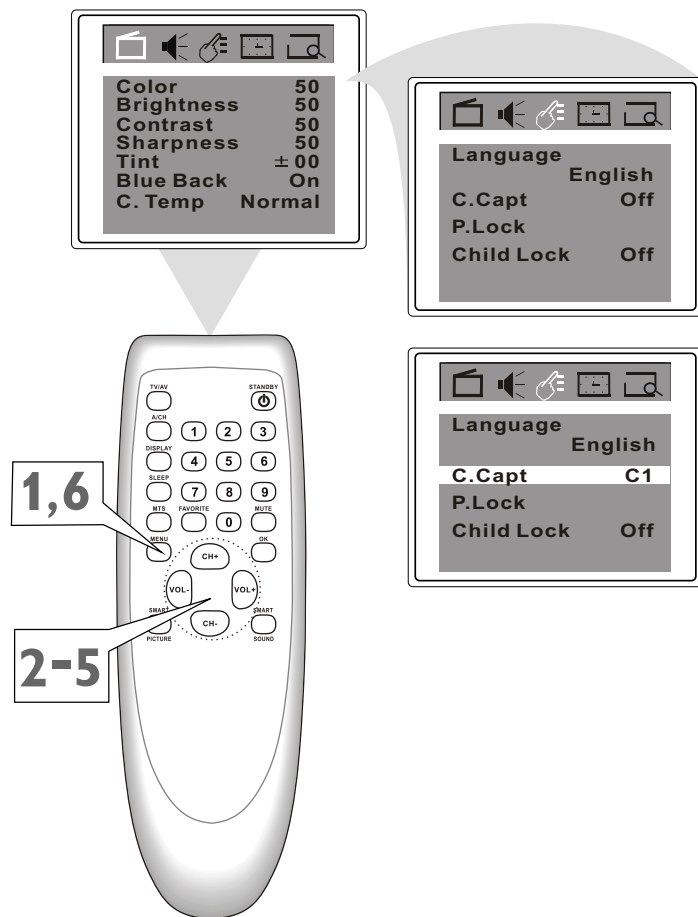

Helpful Hints

Not all TV programs and commercials are broadcast with Closed Caption information. Neither are all Closed Caption modes transmitted by a station for a closed caption program. See your TV listings for the stations and times of Closed Caption shows.



Sleep Timer

Have you ever fallen asleep in front of the TV, only to have it wake you up at two in the morning with a test pattern screeching in your ears? Well, your TV can save you that trouble by turning itself off.

- 1 Press SLEEP.** The sleep display will appear on the screen.
- 2 Within five seconds, press SLEEP** to pick the amount of time (in 10-minute decrements) before the TV will turn itself off.

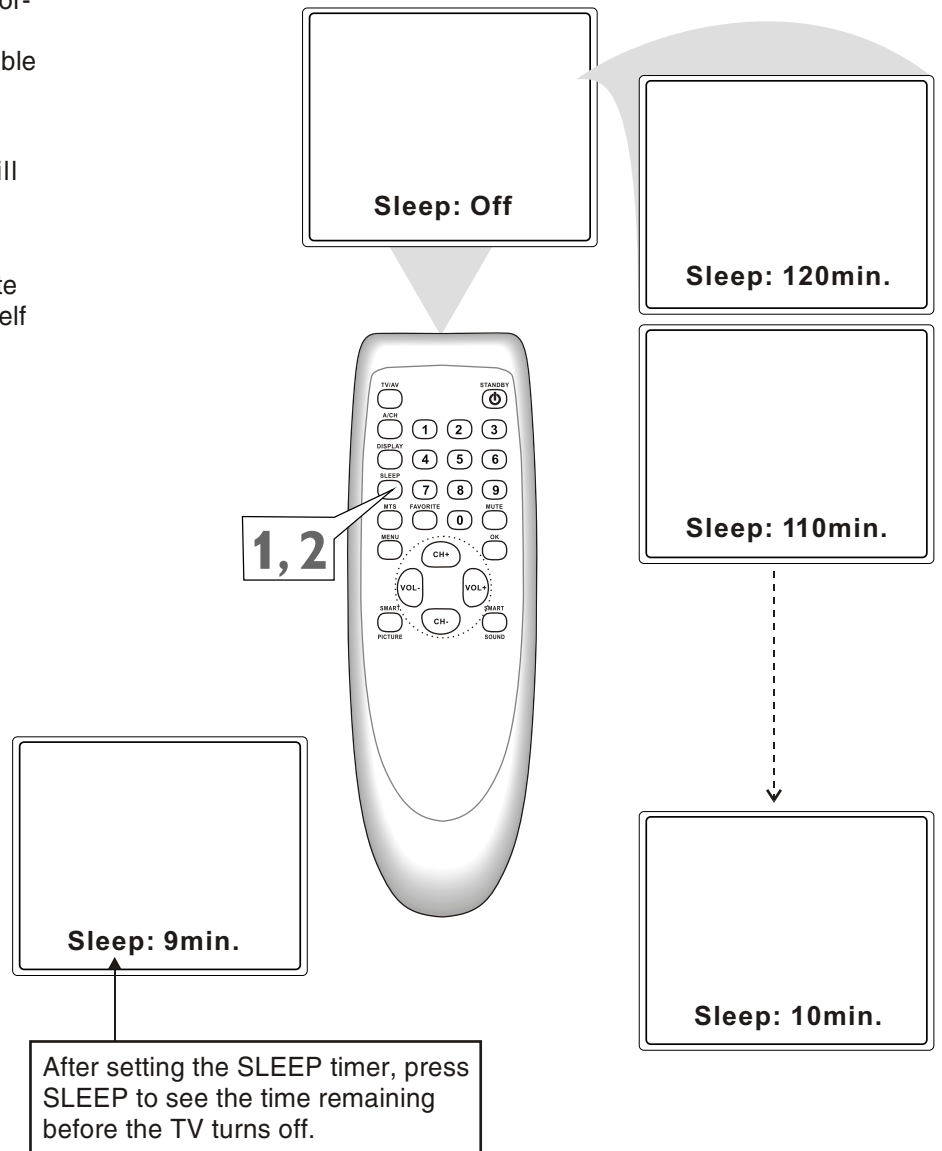

Understanding Parental Lock



Parental Lock processes program content advisories from broadcasters. Parental Lock can respond to the content advisories and block objectionable content (offensively language, violence, sexual situations, etc.) This is a great feature to censor the type of programming children watch. **Parental Lock offers various blocking options from which to choose:**

MASTER ENABLE: this is the “master switch” for Parental Lock. When ON, all blocking/censoring you have set is enabled. When off, all blocking is disabled.

BLOCK UNRATED: All unrated programs (based on Movies Ratings or TV Ratings) will be blocked if this feature is ON and MASTER ENABLE is ON.

BLOCK NO RATING: All programming with no content advisory data will be blocked if this feature is ON and MASTER ENABLE is ON.

After you set a secret code, you can block up to six ratings in TV Ratings or Movie Ratings. These ratings are set by the Motion Pictures Association of America and TV broadcasters.

MPAA Ratings

(Motion Picture Association of America)

G: General Audience - All ages admitted. Most parents would find this program suitable for all ages. This type of programming contains little or no violence, no strong language, and little or no sexual dialog or situation.

PG: Parental Guidance Suggested - This programming contains material that parents may find unsuitable for younger children. It may contain one or more of the following: moderate violence, some sexual situations, infrequent coarse language, or some suggestive dialog.

PG-13: Parents Strongly Cautioned - This programming contains material that parents may find unsuitable for younger children under the age of 13. It contains one or more of the following: violence, sexual situations, coarse language, or suggestive dialog.

R: Restricted - This programming is specially designed for adult. Anyone under the age of 17 should only view the this programming with an accompanying parent or adult guardian. It contains one or more of the following: intense violence, intense sexual situations, strong coarse language, or intensely suggestive dialog.

NC17: No children under the age of 17 will be admitted - This type of programming should be viewed by adults only. It contains graphic violence, explicit sex, or crude, indecent language.

X: Adult only - This type of programming contains one or more of the following: very graphic violence, very graphic and explicit sexual acts, very coarse and intensely suggestive language.

TV Ratings

(TV broadcaster)

TV Y **TV-Y All children**-Appropriate for all children. - Designed for a very young audience, including children age 2-6. This type of programming is not expected to frighten younger children.

TV Y7 **TV-Y7 Directed to Older Children** - Designed for children age 7 and above. It may be appropriate for children who can distinguish between make-believe and reality. This programming may include mild fantasy and comic violence (FV or Fantasy violence).

TV G **TV-G General Audience** - Most Parents would find this programming suitable for all ages - This type of programming contains little or no violence, no strong language, and little or no sexual dialog or situation.

TV PG **TV-PG Parents Guidance Cautioned** - Contains material that parents may find unsuitable for younger children. This type of programming contains one or more of the following: moderate violence(V), some sexual situations(S), infrequent coarse language (L), or some suggestive dialog (D).

TV 14 **TV-14 Parents Strongly Cautioned** - Contains material that parents may find unsuitable for children under 14 years of age. This type of programming contains one or more of the following: intense violence (V), intense sexual situations(S), strong coarse language (L), or intensely suggestive dialog (D).

TV MA **TV-MA Mature Audience only** - Specially designed to be viewed by adults and may be unsuitable for children under 17. This type of programming contains one or more of the following: graphic violence (V), explicit sexual situations(S), or crude, indecent language (L).



Parental Lock Secret Code

Over the next few pages, you will learn how to block programs and understand the rating terms for certain broadcasts. First, set a secret code.

- 1** Press **MENU** to see the menu.
- 2** Press **VOL+ or VOL-** to highlight **Feature**.
- 3** Press **CH-** to enter Feature submenus.
- 4** Press **CH+ or CH-** to highlight **P.Lock**.
- 5** Press **OK**. The display asking you to **Enter secret code** will appear on the screen.
If you want to set a new code, go on the steps 6-8 directly. (Or you can press the Number buttons to enter a four-digit code. The code "0000" is the default of the TV. If you have not set up a code previously, then "0000" is the code.)
- 6** Press **VOL+ (on the remote) and the CH+ button on the front of the TV at the same time**. The display asking you to **Enter new code** will appear on the screen.
- 7** Press the **Number buttons to enter a four-digit code**. The code will appear on the screen as you enter it.
- 8** Press **OK** to save the code.
- 9** Press **MENU repeatedly** to remove the menu from the screen or the menu will automatically disappear within a few seconds if no buttons are pressed on the remote control.

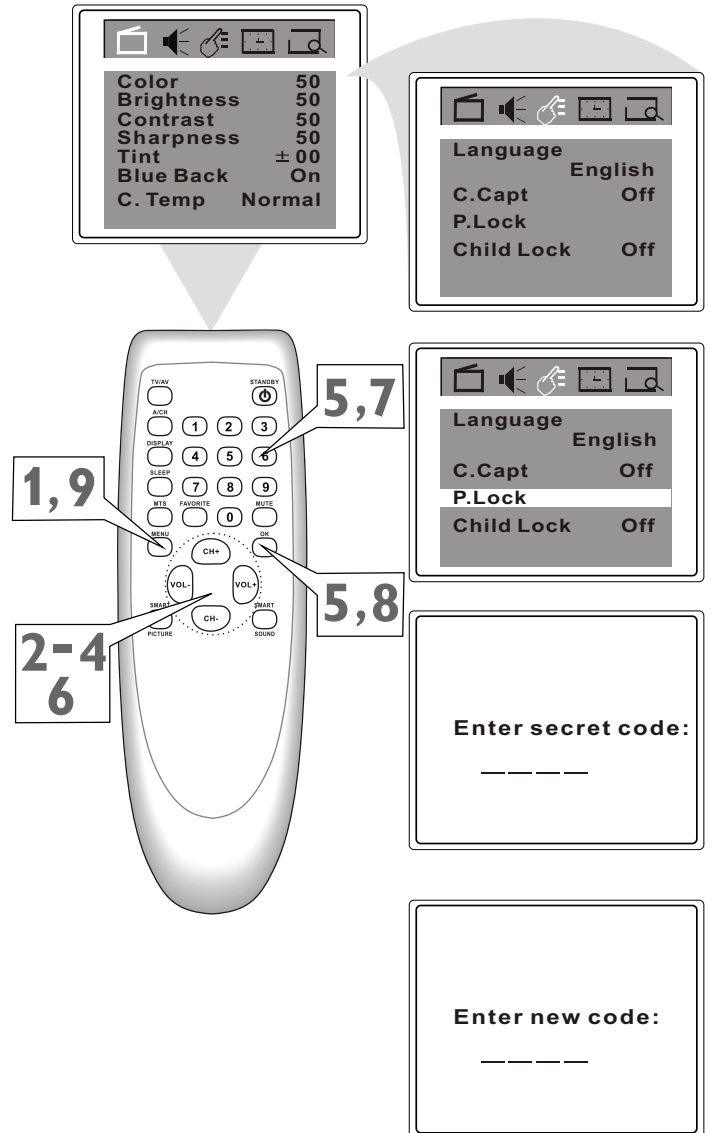

Helpful Hints

You cannot change Parental Lock settings without knowing the secret code. If your code changes, or someone else has altered it and possibly viewed blocked channels.

Blocking Programming with Movie Ratings



There are two types of ratings for P. Lock. One is based on movie industry ratings. The other is based on TV industry ratings. Both can be used to censor programming. Let's first look at the MPAA Rating options of P. Lock.

- 1** Press **MENU** to see the menu.
- 2** Press **VOL+ or VOL-** to highlight  (Feature).
- 3** Press **CH-** to enter Feature submenus.
- 4** Press **CH+ or CH-** to highlight **P.Lock**.
- 5** Press **OK** to display the secret code screen.
- 6** Press the **Number buttons** to enter your four-digit code. The P.Lock setup menu appears on the screen and the MPAA rating is highlighted.
- 7** Press **OK** to display MPAA ratings (**G, PG, PG-13, R, NC-17, and X**).
- 8** Press **CH+ or CH-** to select the rating you want to block.
- 9** Press **OK** to block (or unblock) the rating. A checkmark will appear to the left of the rating when blocked. When you block a rating, higher ratings are blocked automatically. To unblock all the ratings, select N/A.
- 10** Press **MENU** repeatedly to remove the menu from the screen or the menu will automatically disappear within a few seconds if no buttons are pressed on the remote control.

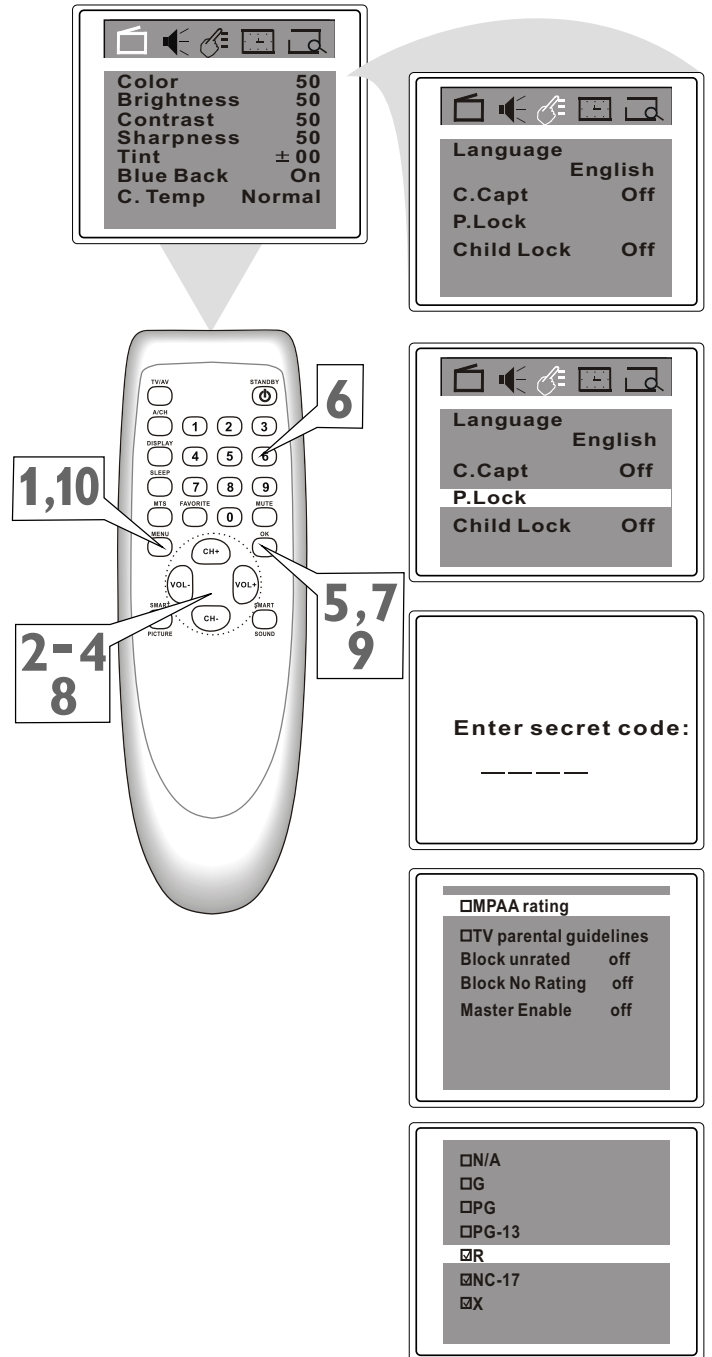

Helpful Hints

Blocking any rating (ON) will block all the higher ratings automatically. For example, if R is blocked manually, NC17 and X will be blocked automatically. To turn a rating OFF, set each rating individually.



Blocking Programming with TV Ratings

Some program ratings are based on TV industry ratings as described below.

- 1 Press **MENU** to see the menu.
- 2 Press **VOL+** or **VOL-** to highlight **Feature**.
- 3 Press **CH-** to enter Feature submenus.
- 4 Press **CH+** or **CH-** to highlight **P.Lock**.
- 5 Press **OK** to display the secret code screen.
- 6 Press the **Number buttons** to enter your four-digit code. The P.Lock setup menu appears on the screen.
- 7 Press **CH+** or **CH-** to highlight **TV parental guidelines**.
- 8 Press **OK** to display the parental guidelines (TV-Y, TV-Y7, TV-G, TV-PG, TV-14, or TV-MA).
- 9 Press **CH+** or **CH-** to select a rating.
- 10 Press **OK** to turn the rating on or off. A checkmark appears when the rating is blocked. TV-Y and TV-PG can be turned on (to block viewing) or off (to allow viewing) only. TV-Y7, TV-PG, TV-14, and TV-MA can be customized to block V (violence), F (fantasy), S (sexual situations), L (coarse language), or D (suggestive dialog). To do so, continue with these steps.
- 11 Press **CH+** or **CH-** to highlight **Content**.
- 12 Press **OK** button to enter the **Content** menu.
- 13 Press **CH+** or **CH-** to select a rating, then press **VOL+**.
- 14 Press **CH+** or **CH-** to select the sub-ratings (**Fantasy-V**, **Violence**, **Sexual**, **Language**, or **Dialog**), then press **OK** to block or view that sub-rating.
- 15 Press **MENU** to return to the Parental Guidelines screen and check your settings. A checkmark appears when the sub-rating is blocked.
- 16 Press **MENU** repeatedly to remove the menu from the screen or the menu will automatically disappear within a few seconds if no buttons are pressed on the remote control.

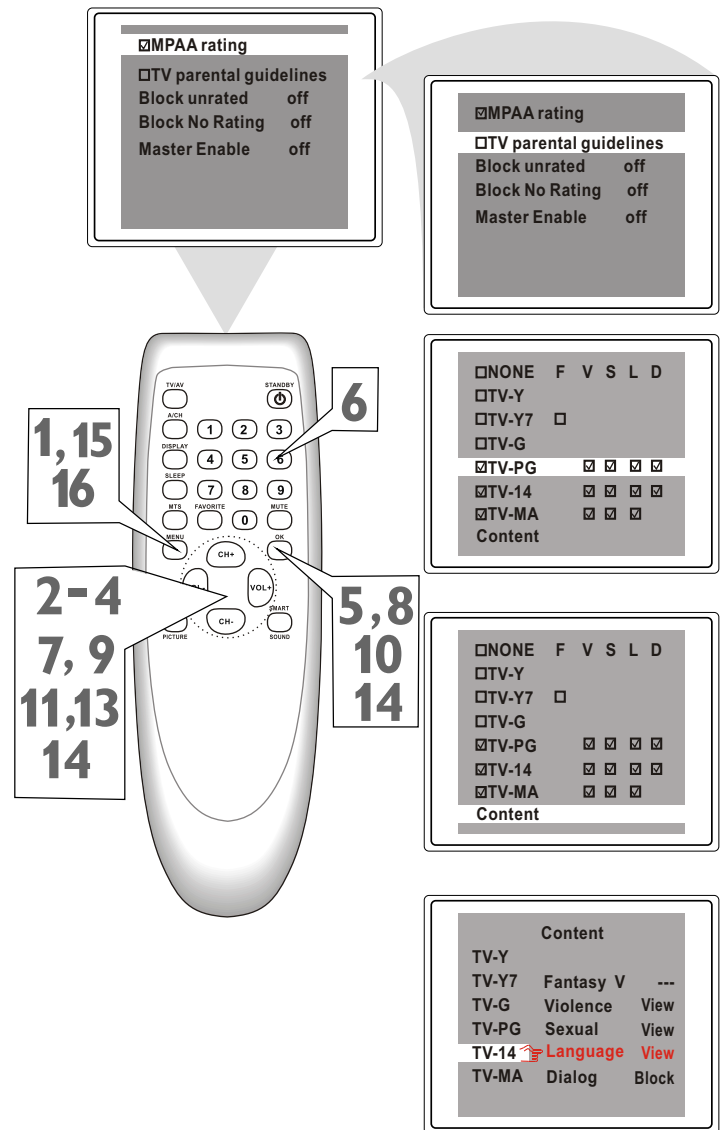

Helpful Hints

Any rating will block higher ratings automatically. To unblock all the ratings, select NONE.

Notes:

1. Blocking TV-Y, only TV-Y7 is blocked automatically.
2. Blocking TV-Y7, other rating will not change any more.

Parental Lock Blocking Options



After setting your secret code, Parental Lock also offers these special blocking options.

- 1** Press **MENU** to see the menu.
- 2** Press **VOL+ or VOL-** to highlight **Feature** (Feature).
- 3** Press **CH-** to enter Feature submenus.
- 4** Press **CH+ or CH-** to highlight **P.Lock**.
- 5** Press **OK** to display the secret code screen.
- 6** Press the **Number buttons** to enter your four-digit code. The P.Lock setup menu appears on the screen.
- 7** Press **CH+ or CH-** to select **Master Enabled, Block Unrated, or Block No Rating**.
MASTER ENABLE: this is the “master switch” for Parental Lock. When ON, all blocking/censoring you have set is enabled. When off, all blocking is disabled.

BLOCK UNRATED: All unrated programs (based on Movies Ratings or TV Ratings) will be blocked if this feature is ON and MASTER ENABLE is ON.

BLOCK NO RATING: All programming with no content advisory data will be blocked if this feature is ON and MASTER ENABLE is ON.
- 8** Press **VOL+ or VOL-** to turn the blocking option **On or Off**.
- 9** Press **MENU** repeatedly to remove the menu from the screen or the menu will automatically disappear within a few seconds if no buttons are pressed on the remote control.

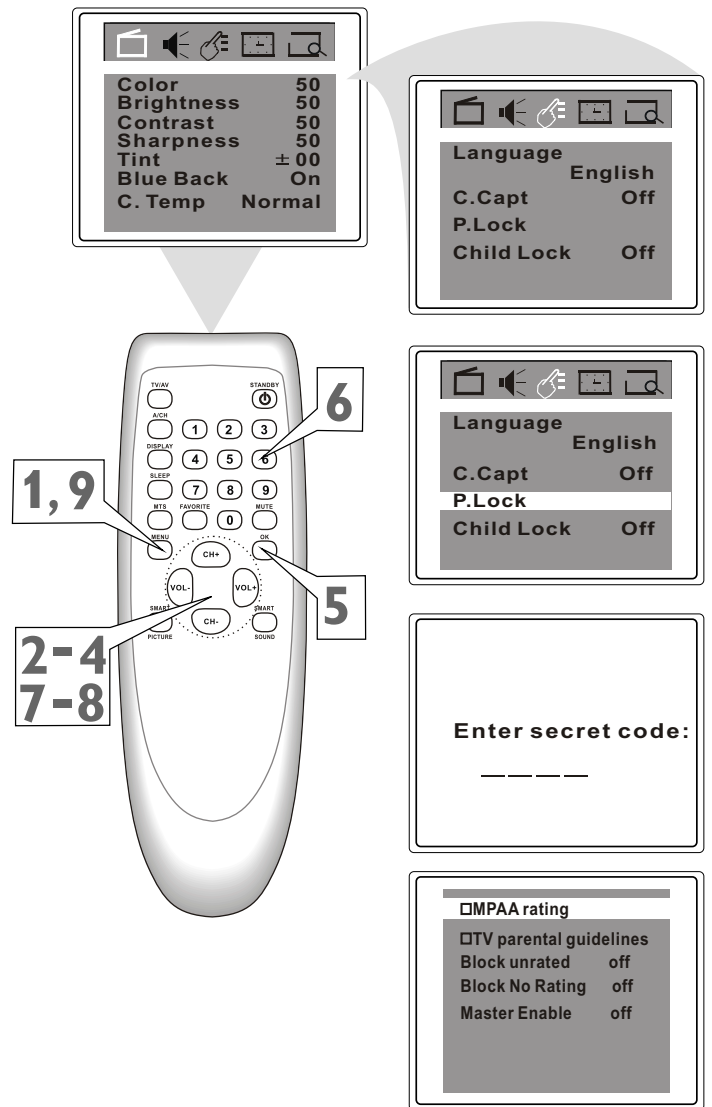



Child Lock

Child Lock allows you to lock the buttons on the front of the TV.

- 1 Press MENU** to see the menu.
- 2 Press VOL+ or VOL-** to highlight  (Feature).
- 3 Press CH-** to enter Feature submenus.
- 4 Press CH+ or CH-** to highlight **Child Lock**.

Choose **ON** to disable all the buttons on the front of the TV. Child Lock On will appear on the TV screen each time when you press the button on the front of the TV.

You can still operate the TV with the remote control. You can still use the **POWER** button on the front of the TV, but only to turn off the TV (not on). Set Child Lock to **Off** to cancel this feature so you can use the buttons on the front of the TV again.

- 5 Press MENU repeatedly** to remove the menu from the screen or the menu will automatically disappear within a few seconds if no buttons are pressed on the remote control.

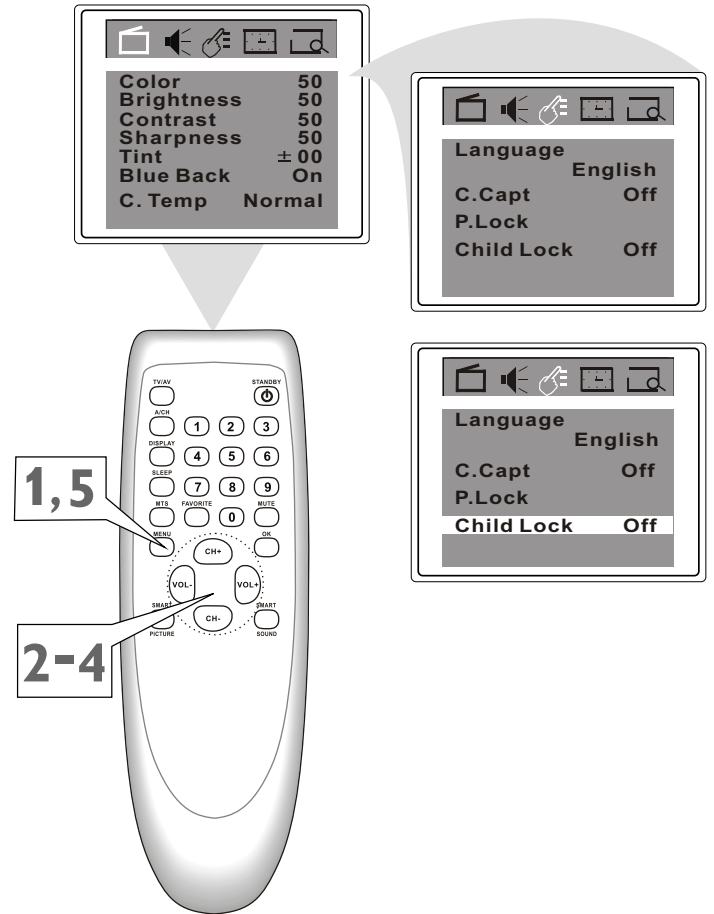



SmartSound offers you four preset sound options: Personal, Theatre, Music or Voice. Choose the one that best suits your current programming.

- 1** Press **MENU** to see the menu.
- 2** Press **VOL+** or **VOL-** to highlight **Sound**.
- 3** Press **CH-** to enter Sound submenus.
- 4** Press **CH+** or **CH-** to highlight **Smart Sound**.
- 5** Press **VOL+** or **VOL-** to select **Personal, Voice, Music, or Theatre**.
- 6** Press **MENU** repeatedly to remove the menu from the screen or the menu will automatically disappear within a few seconds if no buttons are pressed on the remote control.

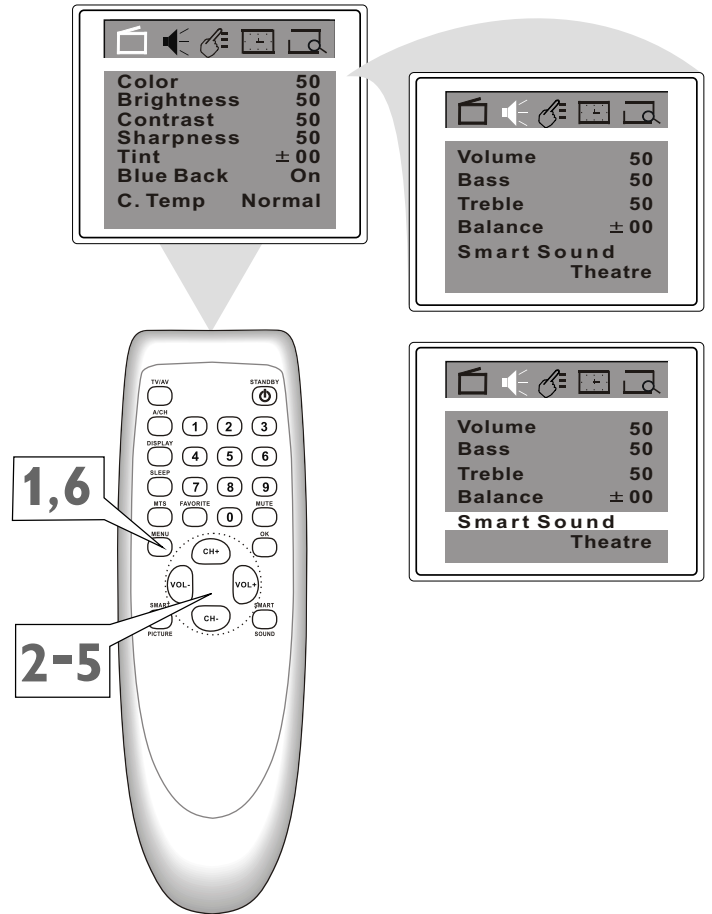

Helpful Hints

You can choose a Smart Sound setting quickly by pressing the **SMART SOUND** button on the remote control.



Sound Adjustments

You can adjust the low frequency (Bass) or high frequency (Treble). You can also adjust the Balance to increase the volume of the left and right sound channels.

- 1 Press **MENU** to see the menu.
- 2 Press **VOL+ or VOL-** to highlight  (Sound).
- 3 Press **CH-** to enter Sound submenus.
- 4 Press **CH+ or CH-** to highlight **Bass** (Volume, Treble or Balance).
- 5 Press **VOL+ or VOL-** to adjust the option.
- 6 Press **MENU** repeatedly to remove the menu from the screen or the menu will automatically disappear within a few seconds if no buttons are pressed on the remote control.

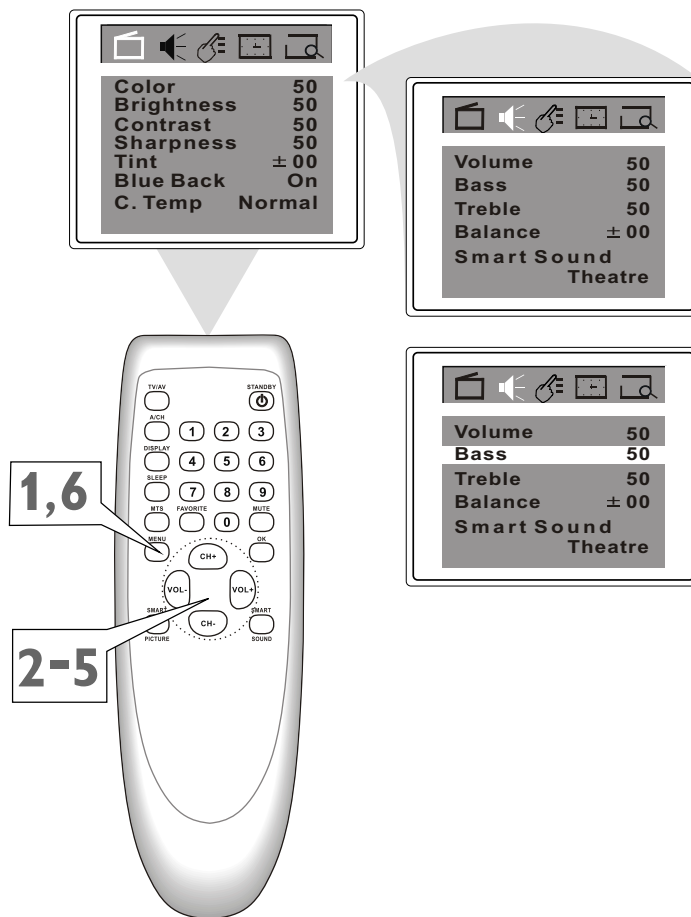

Helpful Hints

- Bass:** Enhances the low frequency sounds.
- Treble:** Enhances the high frequency sounds.
- Balance:** Distributes the sound between the left and right speakers of the TV.

Stereo and Second Audio Program



Multi-channel Sound (MTS) broadcasts enhance TV viewing by bringing you programs with high fidelity stereo sound.

MTS also provides an extra channel called the Second Audio Program (SAP), which broadcasters can use to transmit a second language or for other purposes.

1 Press **MTS** on the remote control to select **STEREO, MONO, SAP, or MONO+SAP**. All the options will be available only when the current TV channel is broadcasting that option. Channels will not always carry programs that have all the MTS options.

If **STEREO** appears on the screen when you select a channel, stereo broadcasting is available with the current TV program. You can hear sound from the left and right speakers of the TV.

If the broadcast is not strong or clear, stereo sound is not available. Press the **MTS** button to change to **MONO**. This should eliminate the noise.

If **MONO** appears on the screen when you choose a channel, Stereo is not available.

If **SAP** appears when you select a channel, Second Audio Program broadcasting is available for the current TV program.

Press the **MTS** button to choose **SAP** and you may hear the program in a different language or some other audio.

If you choose **MONO+SAP** by pressing the **MTS** button, you will hear both the Second Audio Program and the regular **MONO** (monaural or single-channel) audio simultaneously.

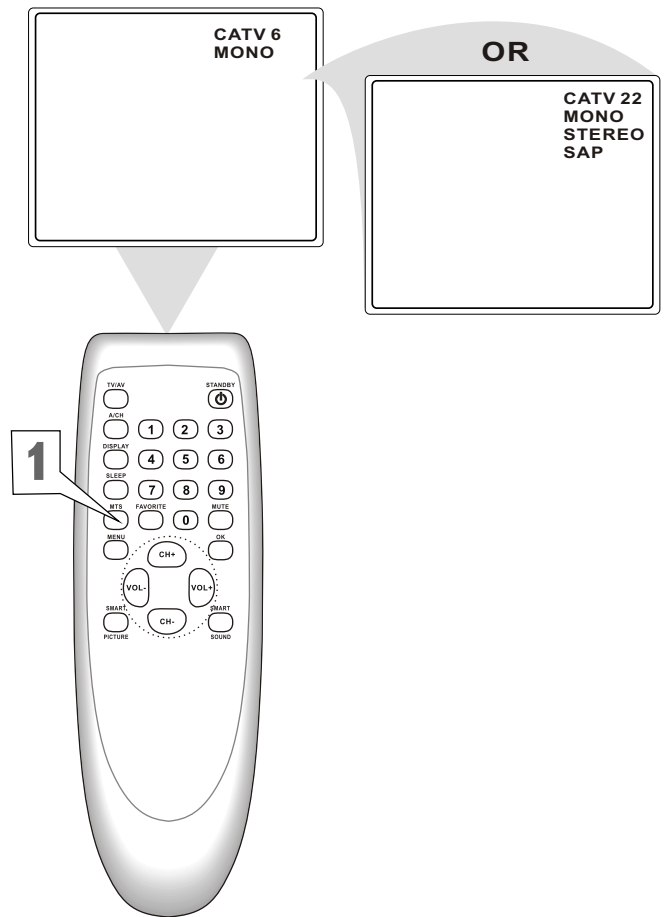



Helpful Hints

No Power

- Check the TV power cord. Disconnect the power cord from the power outlet for 10 seconds, then reinsert the plug into the outlet. Press the STANDBY button to turn on the TV again.
- Make sure the outlet is not on a wall switch.
- Make sure a fuse has not blown at the power outlet.

No Picture

- Check the antenna or Cable TV connections. Connect the antenna or Cable TV signal securely to the TV's 75 OHM ANTENNA INPUT jack on the rear of the TV.
- Set TV/CATV correctly. Details are on page 11.
- Activate AUTO SEARCH to find all available channels. Details are on page 12.
- Press TV/AV on the remote control to select TV channels or a video source (AV1/S-VIDEO, AV2, or YUV). Use AV1 /S-VIDEO, AV2, or YUV to view material on other equipment (Camcorder, VCR, DVD Player, etc.) that is connected to the TV's Audio and Video In jacks.

No Sound

- Press the VOL+ and VOL- buttons to adjust the volume.
- Press the MUTE button on the remote control to cancel or restore the volume.

Remote Control does not work.

- Check the batteries. If necessary, replace them with two AA heavy duty (zinc chloride) or alkaline batteries.
- Clean the remote control as well as the remote control sensor on the front of the TV.
- Check the TV power cord. Disconnect the power cord from the power outlet for 10 seconds, then reinsert the plug into the outlet. Press the STANDBY button to turn on the TV again.
- Make sure the outlet is not on a wall switch.
- Make sure a fuse has not blown at the power outlet.
- Always point the remote control toward the front of the TV (toward the remote sensor).

TV displays wrong channel or no channels.

- Repeat channel selection.
- Add the channel number(s) into the TV's memory. Use ADD/ERASE as described on page 15.
- Make sure TV/CATV is set correctly. Details are on page 11. Then activate AUTO SEARCH to set up all available channels. Details are on page 12.



Care and Cleaning

WARNING concerning stationary images on the TV screen: Do not leave fixed images on the screen for extended periods of time. This can cause uneven aging of the picture tube.

Normal use of the TV should involve viewing of programs that have constantly moving or changing images. Do not leave non-moving images on screen for extended periods of time. Do not display the same images too frequently; subtle "ghost" images can be left on the picture tube. Sources of stationary images may be Laser discs, video games, Compact Discs Interactive (CD-i), or paused Digital Video Discs (DVDs) or videotapes.

Here are some common examples of stationary images:

- **DVD menus** - listings of DVD content.
- **Letterbox black bars** - appear at the top and bottom of the TV screen when a wide screen (16:9) movie is viewed on a TV with standard (4:3) aspect ratio. This is available with some DVDs.
- **Video-game images and scoreboards**
- **Television station logos** - These cause a problem if they are bright and stationary. Moving or low-contrast graphics are less likely to damage the picture tube.
- **Stock-market tickers** - may appear at the bottom of the TV screen if the TV programming covers this news.
- **Shopping channel logos, pricing displays** - These may be bright and may appear constantly during the show. These are usually in the same location on the TV screen.

TV LOCATION

- To avoid cabinet warping, cabinet color changes, and an increased chance of TV failure, do not place the TV where temperatures can become excessively hot (for example, in direct sunlight or near a heating appliance).
- Allow a free flow of air around the TV.

CLEANING

- To avoid possible shock hazard, remove the TV's power cord from the electrical outlet before cleaning.
- Regularly dust the TV with a dry, non-scratching duster.
- When cleaning the TV, take care not to scratch or damage the screen surface. Avoid wearing jewelry or using anything abrasive. Do not use household cleaners. Wipe the screen with a clean cloth dampened with water. Use even, easy, vertical strokes when cleaning.
- Gently wipe the cabinet surfaces with a clean cloth or a sponge dampened in a solution of cool, clear water and a mild soap or detergent. Use a clean, dry cloth to dry the wiped surfaces.
- Occasionally vacuum the vents on the rear of the TV.
- Never use thinners, insecticide sprays, or other chemicals on or near the cabinet. They may blemish the cabinet permanently.

Glossary



Audio/Video Inputs • Jacks (standard RCA) on the rear of the TV to which you connect accessory devices. These jacks receive picture and sound from equipment such as a DVD Player, VCR, Camcorder, etc..

Auto Program • Scans all available channels from regular antenna or Cable TV signals and stores only active stations in the TV's memory.

Closed Captioning • The broadcast feature that lets you read the voice content of television programs on the TV screen. Designed to help the hearing impaired, Closed Captioning shows dialog, activity, and conversations while a TV program is in progress.

Coaxial Cable • A single solid wire normally matched with a metal plug (F-type) end connector that screws (or pushes) directly onto a 75-ohm input on the television or VCR.

Menu • An on-screen list of controls available for adjustment.

On-screen Displays (OSD) • Messages that help you set up features (color adjustment or channel programming, for example).

Remote Control Sensor • The window or opening on the front of the TV through which infrared remote control signals are received.

Index



Add/Erase Channels	15	On-Timer	19
Antenna Connection	6	Off-Timer	20
Audio jacks	7	Parental Lock	
Auto Search	12	Blocking Options	27
Sound Adjustments	30	Movie Ratings	25
Battery Installation	8	Secret Code	24
Blue Back (background)	16	TV Ratings	26
Brightness	16	Understanding Parental Lock	23
Cable TV Connection	5	Picture	16
Channel Setup	12	Picture Adjustments	16
Child Lock	28	Registration	2
Cleaning	32	Remote Control	8-9
Clock	18	S-Video	7
Closed Captions	21	Safety	3
Color	16	Second Audio Program (SAP)	31
Component Video Connections (DVD Player)	7	Sharpness	16
Contrast	16	Sleep Timer	22
DVD video in channel	7	SmartPicture	17
DVD (Y Cb Cr) video in jacks	7	SmartSound	29
Factory Service	34-35	Stereo	31
Glossary	33	Tint	16
Helpful Hints	32	TV/Cable TV	11
Language	10	Warranty	36
Manual Channel Tuning	13	Y Cb Cr (DVD) video in jacks	7
Mono	31		



FACTORY SERVICE LOCATIONS

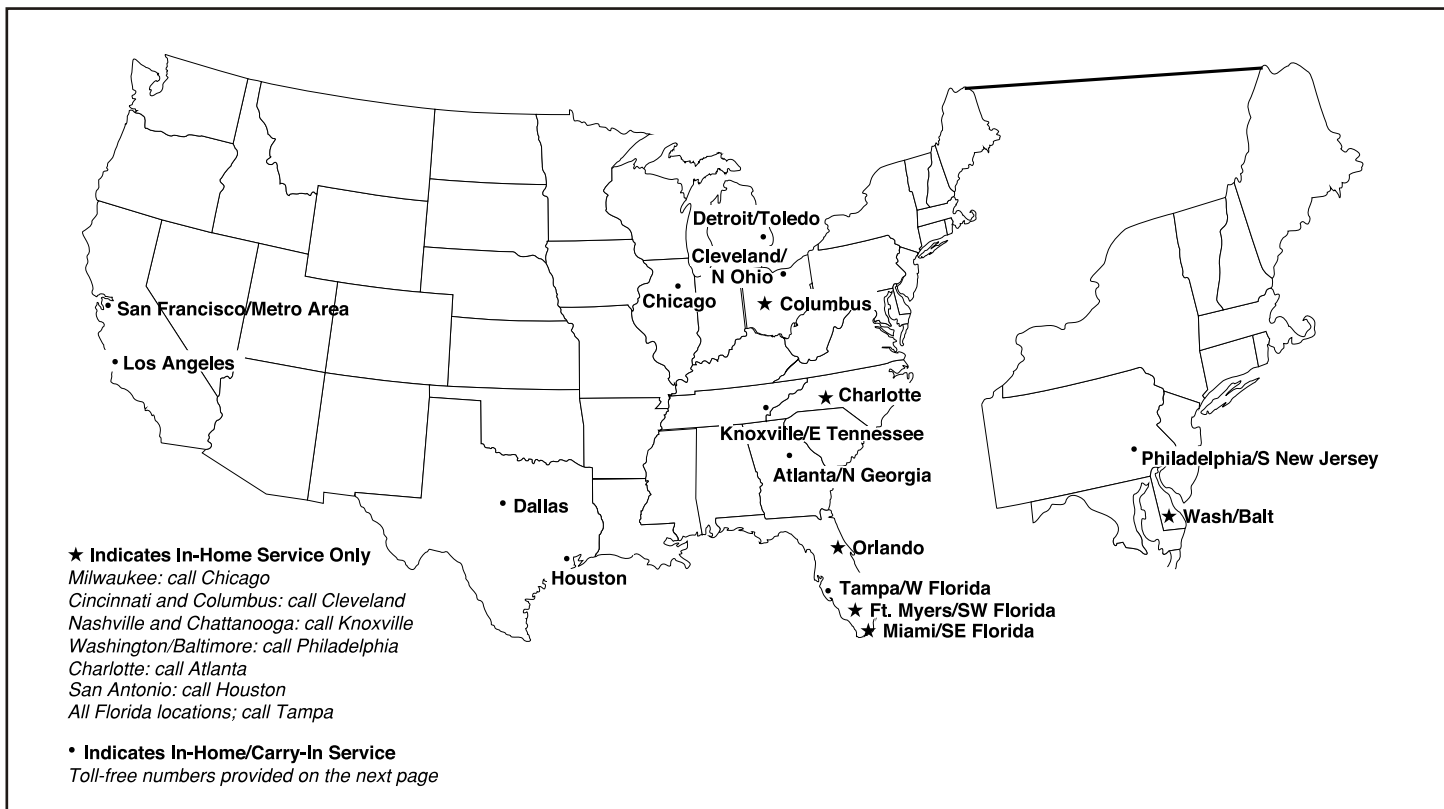

NOTE: Magnavox has chosen Philips Factory Service as its preferred, authorized servicer. Please contact a Philips Factory Service Center. If you reside in one of our Philips Factory Service Branch areas, you can contact the nearest Service Branch to obtain efficient and expedient repair for your product. If your product is In-Warranty, you should have proof-of-purchase to ensure No Charge Service. For Out-of-Warranty service, call the location nearest you.

NOTA: Si vous résidez dans une des régions desservies par une succursale de service après vente du fabricant Philips (voir liste ci-dessous), vous pourrez contacter la branche de service après vente la plus près de chez vous pour obtenir un service après vente rapide et efficace. Si le produit est sous garantie, il suffira de présenter une preuve d'achat pour bénéficier d'un service sans frais. Pour les produits non couverts par la garantie, contactez le centre le plus près de chez vous.

NOTA: Si Ud. reside en una de nuestras zonas para sucursales Philips de servicio al de fábrica (ver directorio más abajo), Ud. puede comunicarse con la sucursal de servicio más cercana para obtener una reparación oportuna y eficaz de su producto. Si su producto está todavía bajo garantía, Ud. debe presentar comprobante de compra para no ocasionar ningunos cargos por servicio. Para servicio después del vencimiento de la garantía, llame al lugar más cercano de los abajo indicados.

In Canada

To obtain efficient and expedient carry-in, mail-in, or in-home service for your product, please contact Magnavox at:
 1-800-661-6162 (French speaking)
 1-800-705-2000 (English or Spanish speaking)

Au Canada

Comment obtenir le service après-vente pour les produits apportés ou envoyés par la poste à notre centre de service ou le service à domicile, veuillez contacter Magnavox à:
 1-800-661-6162 (Francophone)
 1-800-705-2000 (Anglais ou Espagnol)

En el Canadá

Cómo recibir servicio eficiente para su producto, en persona, por correo o a domicilio, favor de comunicarse con Magnavox al:
 1-800-661-6162 (francófono)
 1-800-705-2000 (Inglés o Español)

FACTORY SERVICE LOCATIONS



QUALITY SERVICE IS AS CLOSE AS YOUR TELEPHONE! SIMPLY LOOK OVER THE LIST BELOW FOR THE NUMBER OF A FACTORY SERVICE CENTER NEAR YOU. MAGNAVOX HAS CHOSEN PHILIPS FACTORY SERVICE AS ITS PREFERRED, AUTHORIZED SERVICER. YOUR PRODUCT WILL RECEIVE EFFICIENT AND EXPEDIENT CARRY-IN, MAIL-IN, OR IN-HOME SERVICE, AND YOU WILL RECEIVE PEACE OF MIND, KNOWING YOUR PRODUCT IS BEING GIVEN THE EXPERT ATTENTION OF PHILIPS FACTORY SERVICE.

COMMENT OBTENIR NOTRE SERVICE APRÈS VENTE RAPIDE ET EFFICACE SOIT PAR COURRIER, À DOMICILE, OU EN SE PRÉSENTANT À UN CENTRE DE SERVICE PHILIPS. PLUS DE 600 CENTRES DE RÉCEPTION DE PRODUITS À RÉPARER À TRAVERS LE PAYS: CONTACTER LE CENTRE DE SERVICE AUX CONSOMMATEURS LE PLUS PROCHE POUR SAVOIR L'EMPLACEMENT DE CES DÉPÔTS DANS UN RAYON DE 50 À 75 MILES (80 KM À 120 KM) DU CENTRE DE SERVICE LOCAL.

CÓMO OBTENER UN SERVICIO OPORTUNO Y EFICIENTE POR CORREO, EN CASA O EN PERSONA PARA SU PRODUCTO A TRAVÉS DE UN CENTRO PHILIPS DE SERVICIO. MÁS DE 600 SITIOS POR TODO EL PAÍS PARA LA RECEPCIÓN DE PRODUCTOS NECESITADOS DE REPARACIONES: COMUNICARSE CON EL CENTRO DE SERVICIO DE FÁBRICA MÁS CERCANO PARA ESTOS LUGARES DENTRO DE UN RADIO DE 80 A 120 KM (50 A 75 MILLAS) DEL CENTRO DE SERVICIO LOCAL.

ATLANTA

Philips Factory Service
550 Franklin Road., Suite F
Marietta, GA 30067
800-273-1501

TAMPA

Philips Factory Service
1911 US Highway 301 North, Suite 100
Tampa, FL 33619
800-442-2027

SAN FRANCISCO

Philips Factory Service
681 East Brokaw Rd.
San Jose, CA 95112
800-300-9013

HOUSTON

Philips Factory Service
1110 N. Post Oak Rd., Suite 100
Houston, TX 77055
800-952-3254

CLEVELAND

Philips Factory Service
950 Keynote Circle
Brooklyn Heights, OH 44131
800-331-7037

DETROIT

Philips Factory Service
25173 Dequindre
Madison Heights, MI 48071
800-438-1398

DALLAS

Philips Factory Service
415 N. Main Street, #107
Euless, TX 76040
800-952-3254

LOS ANGELES

Philips Factory Service
20930 Bonita, Ste.V
Carson, CA 90746
800-300-9013

CHICAGO

Philips Factory Service
1279 W. Hamilton Pkwy.
Itasca, IL 60143
800-531-2922

KNOXVILLE

Philips Factory Service
One Philips Drive
Building 2
Knoxville, TN 37914
800-821-1767

PHILADELPHIA

Philips Factory Service
354 Dunks Ferry Rd.
Bensalem, PA 19020
800-847-9320

LIMITED WARRANTY

COLOR TELEVISION

90 Days Free Labor

One Year Parts Exchange

This product must be carried in for service.

WHO IS COVERED?

You must have proof of purchase to receive warranty service. A sales receipt or other document showing that you purchased the product is considered proof of purchase.

WHAT IS COVERED?

Warranty coverage begins the day you buy your product. For 90 days thereafter, all parts will be repaired or replaced free, and labor is free. From 90 days to one year from the day of purchase, all parts will be repaired or replaced free, but you pay for all labor charges. After one year from the day of purchase, you pay for the replacement or repair of all parts, and for all labor charges.

All parts, including repaired and replaced parts, are covered only for the original warranty period. When the warranty on the product expires, the warranty on all replaced and repaired parts also expires.

WHAT IS EXCLUDED?

Your warranty does not cover:

- labor charges for installation or setup of the product, adjustment of customer controls on the product, and installation or repair of antenna systems outside of the product.
- product repair and/or part replacement because of misuse, accident, unauthorized repair or other cause not within the control of Magnavox.
- reception problems caused by signal conditions or cable or antenna systems outside the unit.
- a product that requires modification or adaptation to enable it to operate in any country other than the country for which it was designed, manufactured, approved and/or authorized, or repair of products damaged by these modifications.
- incidental or consequential damages resulting from the product. (Some states do not allow the exclusion of incidental or consequential damages, so the above exclusion may not apply to you. This includes, but is not limited to, prerecorded material, whether copyrighted or not copyrighted.)
- a product used for commercial or institutional purposes.

WHERE IS SERVICE AVAILABLE?

Warranty service is available in all countries where the product is officially distributed by Magnavox. In countries where Magnavox does not distribute the product, the local Magnavox service organization will attempt to provide service (although there may be a delay if the appropriate spare parts and technical manual(s) are not readily available).

MAKE SURE YOU KEEP...

Please keep your sales receipt or other document showing proof of purchase. Attach it to this owner's manual and keep both nearby. Also keep the original box and packing material in case you need to return your product.

BEFORE REQUESTING SERVICE...

Please check your owner's manual before requesting service. Adjustments of the controls discussed there may save you a service call.

TO GET WARRANTY SERVICE IN U.S.A., PUERTO RICO, OR U.S. VIRGIN ISLANDS...

Contact a Magnavox factory service center (see enclosed list) or authorized service center to arrange repair.

(In U.S.A., Puerto Rico, and U.S. Virgin Islands, all implied warranties, including implied warranties of merchantability and fitness for a particular purpose, are limited in duration to the duration of this express warranty. But, because some states do not allow limitations on how long an implied warranty may last, this limitation may not apply to you.)

TO GET WARRANTY SERVICE IN CANADA...

Please contact Magnavox at:

1-800-705-2000

(In Canada, this warranty is given in lieu of all other warranties. No other warranties are expressed or implied, including any implied warranties of merchantability or fitness for a particular purpose. Magnavox is not liable under any circumstances for any direct, indirect, special, incidental or consequential damages, howsoever incurred, even if notified of the possibility of such damages.)

REMEMBER...

Please record below the model and serial numbers found on the product. Also, please fill out and mail your warranty registration card promptly. It will be easier for us to notify you if necessary.

MODEL # _____

SERIAL # _____

This warranty gives you specific legal rights. You may have other rights which vary from state/province to state/province.

Magnavox, P.O. Box 520890, Miami, FL 33152 (402) 536-4171
EL6541E001